

Moers, Germany | Sales + Showroom // Gharieni Group GmbH • Gutenbergstr. 40 • D-47443 Moers

Moers, Germany | Distribution + Service // Gharieni Group GmbH • Am Schürmannshütt 24 • D-47441 Moers

Tel: +49 - (0) 28 41 - 88 300 - 0 • Fax: +49 - (0) 28 41 - 88 300 - 333 • www.gharieni.de • info@gharieni.com

Ettlingen // Gharieni Süd GmbH • Siemensstr. 11 • D-76275 Ettlingen

Tel: +49-(0)72 43-3322-363 • Fax: +49-(0)72 43-3322-391 • ettlingen@gharieni.com

Nederweert | BeNeLux // Gharieni Nederland BV • Hulsenweg 14 • NL-6031 SP Nederweert

Tel: +31 (0) 495 - 63 30 36 • Fax: +31 (0) 495 - 62 66 63 • www.gharieni.nl • info@gharieni.nl

Dubai | UAE // Gharieni Middle East FZ-LLC • Park Hyatt Hotel • Dubai Creek Club St., P.O. Box 333203 • Dubai

Tel: +971 (0) 4 602 1819 • www.gharieni.ae • info@gharieni.ae

Aventura | USA // Gharieni USA Inc. • JW Marriott Miami Turnberry Resort & Spa • 19999 West Country Club Drive Aventura

Florida 33180 • Tel: +1 (855) 378 4772 • www.gharieni.com • info@gharieni.com



GREEN SPA is a sustainability initiative of the German Wellness Association for the spa and wellness industry. Our company supports the sustainable operation of spa and wellness facilities with suitable products and/or services.



Contents

Treatment Table Options	page 14				
Mind Body Wellness Technologies	page 22				
MLX Quartz	page 24				
Welnamis	page 34				
RLX Satori	page 40				
RLX Aurasens	page 44				
Augmented Massage	page 48				
MLX i³Dome / iDome	page 50				
G-Vac	page 60				
HydroSpa	page 62				
PediSpa Square	page 64				
PediSpa Compact	page 68				
PediSpa Curve	page 72				
Hair Swing	page 78				
Libra Edge	page 80				
MLR Wet	page 86				
Spa Tables	page 90				
MLX Limber series	page 92				
MLX	page 100				
MLR Classic	page 106				
MLR Select series	page 110				
MO1 Evo Neo series	page 120				
MO1 Max	page 124				
		MLW F1 Neo series	page 130		
		MLW Neo series	page 136		
		MLE Neo	page 144		
		Spa Table accessories	page 146		
		Loungers	page 150		
		Evo Lounger	page 152		
		RLR	page 158		
		RL Aqua	page 159		
		RLX series	page 164		
		Massage Tables	page 168		
		MLW Transform	page 170		
		ML series	page 176		
		Ayurveda Table	page 180		
		Shiatsu Mat	page 186		
		Massage Tables accessories	page 188		
		Treatment Beds	page 190		
		Lina Select series	page 192		
		601 series	page 200		
		SPL Neo series	page 206		
		SLR	page 212		
		Hydraulic series	page 216		
		Treatment Beds accessories	page 218		
		Treatment Units	page 220		
		Spa Trolley HST	page 222		
		Spa Trolley GST	page 224		
		AluVap	page 226		
		Shiro Dhara series	page 230		
		Furnishings	page 234		
		K8 Furniture series	page 236		
		K10 Furniture series	page 240		
		MLX Trolley series	page 248		
		MO Trolley	page 254		
		Square Trolley	page 256		
		K9 Trolley	page 260		
		GL Trolley series	page 262		
		Cube Trolley series	page 264		
		Vario Trolley series	page 266		
		Lamica Trolley series	page 268		
		Manicure Table Mano	page 272		
		Manicure Table Cube Select	page 274		
		Stools & Chairs	page 278		

Our awards

Our vision has been affirmed through numerous awards received from the wellness, cosmetic, and medical industries, which acknowledge our individual products, innovative developments, top-notch quality, exceptional design, excellent service, and guarantee standards.

Perfect Spa Awards- Best Wellness Equipment 2022 (Welnamis)
 Spa & Wellness MexiCaribe Product Award 2022 (HST Trolley)
 Pioneer Of Wellness 2020 (Gharieni Celliss)
 Spa & Wellness MexiCaribe Product Award 2020 (MLX i3Dome)
 Innovation Award Deutscher Wellness Verband 2020 (MLX i3Dome)
 Gold Award Aesthetic & Spa Awards 2020 Griechenland (Rubrik Spa Equipment)
 Beauty Forum Sonderpreis der Redaktion – International Top Brand Spa Award 2018
 ESPA Innovation Awards 2018 Special Jury Price (Spa.Wave System)
 Spa & Wellness MexiCaribe Product Award 2017 (Spa.Wave System)
 American Spa Magazine Professionals Choice Award 2017 (HydroSpa)
 Beauty Forum Sonderpreis der Redaktion – Spa International Award 2016/17
 Spa & Wellness Mexico Product Awards 2016 (Wellmassage 5D)
 ESPA – Winner „Innovative Spa Concept“ 2016 (Wellmassage 5D)
 Wellness & Spa Innovation Award 2016 (Wellmassage 5D)
 Dermascope Aesthetician Choice Awards 2016 (PediSpa Square)
 Spa Professional Mexico Product Award for Best Spa Furniture 2015 (MLX Quartz)
 Beauty Forum Sonderpreis der Redaktion – Spa International 2014
 Beauty Forum Readers' Choice Award 2013/2014
 Beauty Forum Award 2012/2013
 Beauty Forum Readers' Choice Award 2011/2012
 Beauty Forum Award 2010/2011
 Beauty Forum Readers' Choice Award 2009/2010

u.v.m.





since 2019

For the fifth time Gharieni Group is Brand Official of Forbes Travel Guide

About Forbes Travel Guide

Forbes Travel Guide is the only independent, global rating system for luxury hotels, restaurants and spas. Started as Mobil Travel Guide in 1958, the company created the first Five-Star rating system in the United States. Today, Forbes Travel Guide's incognito inspectors travel the world, evaluating properties based on up

to 900 rigorous, objective standards. The company's annual Star Ratings, reviews and daily travel stories help discerning travelers select the world's best luxury experiences.

Read more about Forbes Travel Guide:
www.forbestravelguide.com

The Gharieni Group is the only spa supplier to have been selected by the prestigious international Forbes Travel Guide as one of its "Brand Officials" - for the fifth year in a row.

This is because Gharieni's world-class products and excellent customer service in the spa and wellness sector meet the high benchmarks and standards that Forbes Travel Guide uses to evaluate spas, luxury hotels and restaurants. This great recognition reflects our engagement to provide our customers with outstanding service, highest comfort and first-class design.

From initial concept to installation, Gharieni strives to provide clients with a memorable and immersive treatment experience by incorporating multi-sensory components and extensive customization options into its products. The designation by Forbes Travel Guide will reinforce our goal to pay utmost attention to the design details and differentiation of our equipment.

"We are pleased to name the Gharieni Group as the Official Spa & Wellness Equipment Manufacturer of Forbes Travel Guide," said Filip Boyen, CEO of Forbes Travel Guide. "Gharieni's team of experts oversees every step of design and customizes spa tables, treatment beds and more based on client need. The company, which has more than 25 years in the business, puts guest experience at the forefront of its innovative products."

The Gharieni Group

With more than 30 years of experience, Gharieni Group GmbH is one of the leading international manufacturers of high-quality spa tables, treatment tables, and equipment for the areas of spa, wellness, cosmetics, and foot care/podiatry.

Our tables and device furnishings, as well as our cosmetic and medical equipment, are sold on all continents in nearly 100 countries worldwide. Luxury hotels as well as high-end spas and resorts around the globe rely on our "Made in Germany" products.

First-class material, outstanding quality, the best functionality, modern design, and exclusive innovations, coupled with the flexibility to respond quickly to customer requirements: that is our company's maxim.

We do not just think of ourselves as a manufacturer of equipment. We are in fact concerned with creating very special well-

ness experiences. Thus we have both the end customer as well therapists in mind. We want to offer end customers unique relaxation and treatment experiences and therapists absolutely comfortable, ergonomic working with our products.

When developing our products, we think it's important to "think outside the box." Our in-house development department works continuously with specialists from other professions. This brain-pool isn't just the birthplace of new ideas. The expertise and innovations of other industry branches are also profitably incorporated here, such as in the fields of medicine and technology. In addition, designers with their expert knowledge are available for visually and functionally convincing implementation.

Our vision is simple: We want to offer you as our customer nothing less than the best possible equipment for unforgettable moments.



Certified Quality

for Gharieni treatment tables
and treatment units

"Made in Germany" production



In order to always live up to the "Made by Gharieni" brand, the standard "quality without compromise" applies in our company. This also includes guaranteed quality, because only this offers customers both transparency and security. In order to provide you with clear facts about the proof of production and to show that social responsibility as well as consumer interests are very important to us, we have put ourselves through a costly certification procedure by TÜV NORD and since early 2012 it's "official." In accordance with the TÜV NORD test criteria, our products in the areas of treatment tables and treatment units may be awarded the seal "Made in Germany!"

Quality management
in accordance with ISO 13485



Of course, our manufacturing and administration are also subject to constant quality control. Comprehensive quality management of business processes has been in existence for over ten years and includes ISO 13485 certifications. As a customer, this guarantees you both product quality and excellent service, a combination that can hardly be found elsewhere!



Cruise Ships AIDA-Cruises, Hyperion-Klasse // TUI Cruises, Mein Schiff 2 - 6 // MS Europa 2 // P&O Pacific Dawn // Celebrity Edge // Norwegian Bliss // Genting Dream, Dream Cruises

Hotels/Spa Resorts Severins Resort & Spa^S Sylt, Germany // THE GRAND Ahrenshoop Ahrenshoop, Germany // // Titanic Hotel Berlin Berlin, Germany // Wellnesshotel Kunzmann's Hotel Bad Bocklet, Germany // Hotel Bülow Palais Dresden, Germany // Hotel Hyatt Regency Düsseldorf/Mainz/Köln, Germany // Grand Hyatt Berlin Germany // Hotel Traube Tonbach Baiersbrunn, Germany // Hotel Sofitel Frankfurt Opera Germany // Steigenberger Hotel Frankfurter Hof Germany // Grand Hotel Heiligendamm Bad Doberan-Heiligendamm, Germany // The Westin Grand München Munich, Germany // Althoff Seehotel Überfahrt Rottach-Egern, Germany // Lindner Hotel Dom Residence Cologne, Germany // Brenners Park-Hotel & Spa Baden-Baden, Germany // Nordseefarm Büsumer Deichhausen, Germany // Relais & Châteaux Hotel Die Sonne Frankenberg^S Germany // Hotel Bergström Lüneburg, Germany // Wellnesshotel Bodenmaier Hof Bodenmais, Germany // Steigenberger Hotel am Kanzleramt Berlin, Germany // Titanic Deluxe Berlin Germany // Titanic Chaussee Berlin Germany // Hotel BEI SCHUMANN^S Schirgiswalde, Germany // Budersand Hotel, Golf & Spa Sylt, Germany // Cliff Hotel Rügen - Resort & Spa Germany // Colombi Hotel Freiburg, Germany // Althoff Grandhotel Schloss Bensberg Bergisch-Gladbach, Germany // Kameha Grand Bonn Germany // The Mandala Hotel Berlin, Germany // Das König Ludwig Schwangau, Germany // Moselromantik-Hotel Keßler-Meyer^S Cochem, Germany // Kempinski Hotel Frankfurt Gravenbruch Neu-Isenburg, Germany // Lindner Parkhotel & Spa Oberstaufen, Germany // InterContinental Düsseldorf Germany // Ulrichshof Baby & Kinder Bio-Resort Rimbach, Germany // Wellings Romantik Hotel zur Linde Moers, Germany // Steigenberger Grandhotel and Spa Heringsdorf, Germany // W Amsterdam Netherlands // Corendon City Hotel Amsterdam Netherlands // The Lamp Hotel Norrköping, Sweden // Hotel Kaiserblick Ellmau Austria // Domaine La Butte aux Bois Lanaken, Belgium // Hotel Sans Souci Vienna, Austria // Grand Tirolia Kitzbühel, Austria // Park Hyatt Vienna Austria // ALGO welcome family Aigen, Austria // Hilton Vienna Plaza Austria // Grand Hotel, Wien Austria // Alpenresort Schwarz Mieming, Austria // Bürgenstock Resort Lake Lucerne Switzerland // The Dolder Grand Zurich, Switzerland // InterContinental Davos Switzerland // W Verbier Switzerland // Seehotel Waldstätterhof Brunnen, Switzerland // The Alpina Gstaad Switzerland // Hotel Crans Ambassador Luxury Sport Resort Crans-Montana, Switzerland // Hotel Plunhof South-Tirol, Italy // Falkensteiner Resort Capo Boi Villasilvius, Italy // JW Marriott Venice Resort & Spa Italy // Preidlhof Luxury DolceVita Resort Naturno, Italy // Mandarin Oriental Milan Italy // Maison Albar Hotel Paris Champs-Élysées France // Hôtel de Crillon, A Rosewood Hotel Paris, France // Hotel Lutetia Paris, France // Hotel Molitor Paris - Mgallery Collection France // Hôtel les bains d'Arguin Arcachon, France // Hotel Sofitel Biarritz le Miramar Thalassa Sea & Spa France // Hôtel La Réserve Paris France // Cala Rossa Grand Hôtel Korsika, France // Hôtel Barrière Les Neiges Courchevel, France // The Ritz-Carlton, Budapest Hungary // The Beaumont London, England // Brimstone Hotel Langdale, England // Sopwell House St Albans England // The May Fair London, England // Mandarin Oriental Mayfair, London England // Radisson Blu Edwardian Manchester, England // Jumeirah Carlton Tower London, England // Ramside Hall Hotel & Spa Durham, England // Grand Jersey Hotel & Spa St Helier, Jersey // Four Seasons Hotel Hampshire England // The Johnstown Estate Johnstownbridge, Ireland // Galgorm Resort & Spa Ballymena, Northern Ireland // Talacre Beach Holiday Home Park Wales // Gazelli House London, England // The Manor House Wiltshire, England // Four Seasons Hotel London at Ten Trinity Square England // Vila Vita Parc Resort and Spa Porches, Portugal // The One Barcelona Spain // SHA Wellness Clinic Alicante, Spain // Sheraton Mallorca Arabella Golf Hotel Palma de Mallorca, Spain // The Ritz-Carlton Istanbul, Turkey // Mandarin Oriental, Bodrum Turkey // The Grand Tarabya Istanbul, Turkey // Maxx Royal Kemer Resort Kemer, Turkey // The Peninsula Istanbul Turkey // JW Marriott Hotel Ankara Turkey // Raffles Istanbul Turkey // Vidago Palace Hotel Portugal // Hotel Metropol Monte Carlo, Monaco // Kempinski Hotel Grand Arena Bansko Bulgaria // Hotel Arlamów Poland // Hilton Tallinn Park Estonia // Four Seasons Hotel Moscow Russia // Bvlgari Hotel & Residences Moscow Russia // Esperanza Resort & SPA Litauen // Belvedere Hotel (Six Senses Spa) Mykonos, Greece // Six Senses Hideaway Zighy Bay Oman // Mandarin Oriental Doha Qatar // The Ritz-Carlton Doha Qatar // Zula Wellness Resort Al Ruwais, Qatar // The St. Regis Red Sea Resort Shura Island, Saudi Arabia // Nujuma, a Ritz-Carlton Reserve Ummahat Alshaikh Island, Saudi Arabia // Sofitel Dubai The Palm Resort & Spa UAE // Caesars Palace Bluewaters Dubai, UAE // Anantara Downtown Dubai Hotel Dubai, UAE // FIVE Palm Jumeirah UAE // Palazzo Versace Dubai UAE // Four Seasons Hotel Abu Dhabi At Al Maryah Island UAE // The Address Downtown Dubai UAE // Talise Spa Madinat Jumeirah Dubai, UAE // Burj Al Arab Dubai, UAE // Emirates Palace Abu Dhabi UAE // The Peninsula Hong Kong // Rosewood Beijing China // Grand Lisboa Palace (Karl Lagerfeld) Macau, China // Four Seasons Resort Langkawi Malaysia // The Chateau Spa & Organic Wellness Resort Kuala Lumpur, Malaysia // Four Seasons Hotel Jakarta, Indonesia // Cheval Blanc Randheli Noonu-Atoll, Maldives // Velaa Private Island Maldives // The Oberoi Sukhvilas Resort & Spa Punjab, India // Anahita The Resort Mauritius // Four Seasons, Mahe Island Seychelles // Four Seasons Hotel The Westcliff Johannesburg, South Africa // Hotel Sofitel Agadir Royal Bay Resort Morocco // Sofitel Marrakech Morocco // The Residence Tunis, Tunisia // La Cigale Tabarka Hôtel-Thalasso & Spa - Golf Tunisia // Crown Towers Perth Australia // Sofitel Abidjan Hôtel Ivoire Côte d'Ivoire // Jumby Bay Resort Antigua // Hilton Barbados // Gran Caribe Kuba // Cheval Blanc St-Barth Saint-Barthélemy // The Brando Tetiaroa French Polynesia // Four Seasons Resort Seychelles at Desroches Island // Jewel Grande Montego Bay Resort and Spa Jamaica // JW Marriott Miami Turnberry

Resort & Spa Miami, USA // Four Seasons Hotel Los Angeles at Beverly Hills California, USA // Carlsbad Oceanfront Resort & Spa California, USA // Grand Hyatt New York USA // Guerlain Spa at The Plaza Hotel NYC, USA // SeaHill Spa at The Cavalier Hotel, Autograph Collection Hotel Virginia Beach, USA // Four Seasons Surf Club Miami USA // Conrad Bora Bora Nui French Polynesia // Cosmopolitan Hotel East Tower Las Vegas, USA // Peninsula Chicago USA // Kona Kai Resort San Diego, USA // The Setai Hotel Miami, USA // La Cantera Hill Country Resort San Antonio, USA // The Breakers Palm Beach, USA // Bergamos Retreat, Friendswood Texas, USA // Four Seasons Hotel Houston Texas, USA

Hot Springs/Thalasso Sieben Welten Hotel und Spa Resort Fulda/Künzell, Germany // Vabali Spa Hamburg Germany // Carolus Thermen Aachen, Germany // Rupertus Therme Bad Reichenhall, Germany // Caracalla Therme Baden-Baden, Germany // Bali Therme Bad Oeynhausen, Germany // Thalassozentrum ahoi! Cuxhaven Germany // Thalasso - Spa Marin La Grande Terrasse Châtelailon-Plage France // ThalassoThérapie Thalazur Cabourg France // Glen Ivy Hot Springs Corona, USA

Day Spas Dr. Barbara Sturm Boutique & Spas // Aiyasha Medical Spa Munich, Germany // Dermedis Germany // Babor Beauty Spas Germany // Flughafen Düsseldorf Germany // Lufthansa Lounge Frankfurt Airport Germany // Nordseefarm Büsumer Deichhausen, Germany // H2 Beauty Lounges Bad Nauheim, Germany // KaDeWe Berlin, Germany // H1-Spa Konstanz, Germany // Lasmiranda Tattoo & Beauty Herrenberg, Germany // HAUT+ Kosmetikinstitut Frankfurt, Germany // BABOR Beauty Spa Wien Vienna, Austria // WAX! Baby Urban Beauty Salzburg, Austria // Dhevari Spa Wien Vienna, Austria // Cosmeda International Rinteln, Germany // Cosmetic Institute Munich Airport, Terminal 2 Germany // Phytomer Spa & Wellness à St Malo France // Clarins Skin Spa Neuilly sur Seine France // Les thermes d'Evian Evian les Bains, France // Printemps Lyon, France // THIRTY NINE Monte Carlo Monaco // Guerlain L'Institut Praha Prague, Czech Republic // AETHER Aesthetic and Beauty Clinic Prague, Czech Republic // Limelight Spa (Rolex) Biel, Switzerland // Lisa Franklin Clinic London, England // Harrods Hair & Beauty Salon London, England // HydraFacial Flagship London, England // Natura Bissé Harrods London, England // The House of Elemis London, England // Lanes of London England // Zabeel Ladies Club Dubai, UAE // Maison Lutétia Paris & Dubai // DIOR Doha Printemps Doha, Qatar // Koroviar Spa Seoul, Korea // King Waterpark Dallas, USA // Island Spa Catalina Catalina Island, USA // Dr. Sears Center for Health and Wellness Palm Beach, USA // Bonita Bay Bonita Springs, USA // The Westin Ka'anapali Ocean Resort Villas Hawaii // Ocean Reef Club Key Largo, USA // Cartesiano Urban Wellness Center Puebla, Mexico

Medical Gesundheitszentrum Jod- Schwefelbad Bad Wiessee, Germany // Aesthetify | Rick & Nick Düsseldorf, Germany // CAPITAL AESTHETICS BERLIN Germany // My Mayr Med Resort Bad Birnbach, Germany // Dr. Jorjani Aesthetics Bonn, Germany // SH Better Skin Ismaning, Germany // Die Ästheten - Medical Spa Munich, Germany // Dermazentrum Munich, Germany // Hautarztpraxis im Vorderen Westen, Kassel, Germany // Dermatologie am Luegplatz Düsseldorf, Germany // Medical Skin Center - Dr. med. David Bacman Cologne, Germany // Ästhetik am HEH, Braunschweig, Germany // Clinique des Champs Elysées France // UMA Institute & Clinic Amsterdam, The Netherlands // Médoc Beauty Belgium // Iuventu Anti-Aging Clinic Brussels, Belgium // Mohs Klinieken Amsterdam, The Netherlands // Fineskin Zurich, Switzerland // Nescens Clinique De Genolier Switzerland // Clinique La Prairie Madrid, Spain // New York Dermatology Group NYC, USA // Dr. Dennis Gross NYC, USA // Cosmetic Surgery & Aesthetic Lounge - Dr. Kevin Sadati Newport Beach, USA // Regenesis Cosmetic Surgery Kent Town, Australia // Biolite Aesthetic Clinic Dubai // Yugen Care by Dr. Gehad Dubai // Highness Beauty Clinic & Spa Dubai

Training Centers Cosmeda Rinteln, Germany // Circadia Europe Wiesbaden, Germany // Traute de Lorenzi Cologne, Germany // Jean d'Arcel Cosmétique Kehl, Germany // Schulungszentrum Academie Scientifique de Beauté Baden-Baden, Germany // Dermalogica Schulungszentren Germany // Dr. Babor Schulungszentrum Aachen, Germany // Klapp Cosmetics Schulungszentren Germany // Malu Wilz Schulungszentrum Munich, Germany // Reviderm Munich, Germany // PUREBEAU Schulungszentrum Berlin, Germany // Dr. Spiller Elixhausen, Austria // KTA Stabroek, Belgium // Maria Galland Trainingscenter Bilthoven, Netherlands // Helene V - Skin Academy Beersel, Belgium // QMS Elen, Belgium // Chamomilla Vollenhove, The Netherlands // Absolution Creative Apothecary Appeldoorn, The Netherlands // Skins Cosmetics Groningen, The Netherlands // Dermalogica Breda, The Netherlands // Thalazur Arcachon, France // ENVIRON Benelux, France

Brands Ligne St. Barth Munich, Germany // Hildegard Braukmann Kosmetik Germany // [comfort zone] Deventer, The Netherlands // IKARI Flagshipstore Antwerp, Belgium // Clarins USA Miami, USA // La Colline, Switzerland // NIANCE World of Luxury, Switzerland // Goldbad, Switzerland // Vinoble Fresing, Austria // Natura Bissé England // and many more!

are you
next?

Our partners



www.elemis.com



www.guerlain.com

CLARINS

www.clarins.de



www.babor.com



www.biologique-recherche.com



www.lignestbarth.com

PHYTOMER

www.phytomer.com

MALU WILZ
BEAUTY COLLECTION

www.maluwilz.de

THÈMAË
PARIS

www.themae.fr

SHISEIDO

www.shiseido.com

académie
SCIENTIFIQUE DE BEAUTÉ

www.academiebeaute.com

REVIDERM

www.reviderm.de

BURGENER
SWITZERLAND

www.drburgener.com

DR. BARBARA
STURM

www.drsturm.com



www.rimpler.de



www.vinoble-cosmetics.at

THALGO
LA BEAUTÉ MARINE

www.thalgo.de

Pietrulla

www.pietrulla.de

PHARMOS NATUR
GREEN LUXURY

www.pharmos-natur.de

GOCO
HOSPITALITY

www.gocohospitality.com

RAUE
Kosmetik- & Fußpflegebedarf

www.raue-shop.de

MONTEIL
PARIS

www.monteil.com

ANNEMARIE
BÖRLIND
NATURAL BEAUTY

www.boerlind.com

VOYA

www.voya.ie



HILDEGARD
BRAUKMANN
www.hildegard-braukmann.de

bamford

www.bamford.co.uk



www.ist.de

La Colline
Swiss Riviera Beauty Treatment

www.colline.fr

GAZELLI
HOUSE

www.gazelliskincare.com



JEAN D'ARCEL
COSMETIQUE

www.jda.de



Cindarella
PARIS

www.cindarella.com



KURLAND
MIT DER KRAFT DER NATUR

www.kurland.de



Dr. Spiller
Pure SkinCare Solutions

www.dr-spiller.com



Goldeneye
THE ANTI-AGEING COSMETICS COMPANY
www.goldeneye.de



NIANCE®
SWITZERLAND

www.niance.ch



SIX SENSES
RESORTS & SPA

www.sixsenses.com



DORN
BRACHT

www.dornbracht.com



VITALIS
DR JOSEPH

www.vitalisdjoseph.com



URB'N
NATURE
ORGANIC COSMETICS

www.urbn-nature.com



KLAFS
MY SAUNA AND SPA

www.klafs.de



PUREBEAU

www.purebeau.com



GERTRAUD
GRUBER
KOSMETIK KULTUR

www.gertraud-gruber.de



La mer
Der Ursprung der Schönheit

www.la-mer.com



absolution
Creative Apothecary

www.absolution.nl

SUSANNE KAUFMANN™

www.susannekaufmann.com



TRAUTWEIN

www.trautwein-gmbh.com



SPA CONNECTORS

www.spaconnectors.com



MARIA GALLAND
PARIS

www.maria-galland.de



AROMATHERAPY
ASSOCIATES
LONDON
www.aromatherapyassociates.com



CINQ MÖNDES
SPA PARIS

www.cinqmondes.com



cNc
SKINCARE
www.cnc-cosmetic.de



RKF
LUXURY LINES
www.rkf.fr



Doctor
Eckstein®
BioKosmetik
www.eckstein-kosmetik.de



KERSTIN
FLORIAN
www.kerstinflorian.com



ANNE SEMONIN
PARIS

www.annesemonin.com

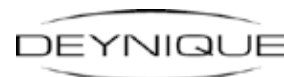

DEYNIQUE

www.deynique.org



SKINCEUTICALS

www.skinceuticals.com



AURA CHAKÉ INST.
PARIS

www.aurachake.fr

...and
many more

Hotel Lutetia

Paris, France





Table Options

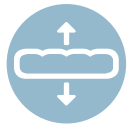

Soft Upholstery

In addition to the standard upholstery, tables with this symbol can also be equipped with a significantly thicker, very soft cushioning. Depending on the type of table, this soft upholstery is available with both a PU and synthetic leather cover. The extra-soft upholstery provides an even higher degree of lying comfort, particularly for longer treatment sessions.



Electrical Arm supports

For even more comfort, the arm supports - as well as the height, the back, leg, and foot section - can be fitted with actuators for electrical adjustment. In addition to direct control via pushbuttons on the arm supports themselves, their position can be conveniently saved using the memory function. This can bring the entire table into the preprogrammed position with the push of a button.



Vibro-Wellness

Vibro-Wellness is a pleasantly massaging vibration system. Ten different vibration motors in the upholstery can be controlled individually via a manual switch. The vibrations work on shoulder (back part), seat, and calves.

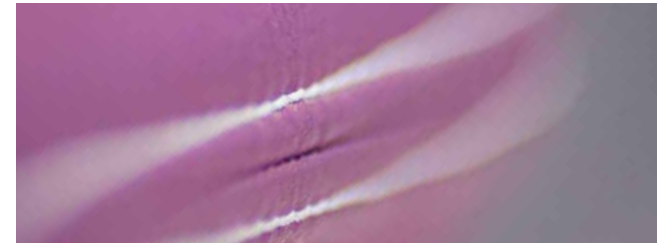



Thermo Heating System

The intelligent Thermo heating system is integrated into the upholstery of the table and works with modern microprocessor technology. During the start-up phase, it heats with full power to achieve a comfortable temperature on the surface as soon as possible. Then, it is kept constant until the safety switch automatically turns off the heating after a predefined time. The variable parameters can be set via a programming sequence, which is initiated by a specific key combination. The heating system works with DC and is therefore almost free from electrosmog.



Logo embroidery

Treatment beds with this symbol have the option of having your logo embroidered into the upholstery or the neck rest. Only possible with synthetic leather upholstery.



(Multi-)Color upholstery

For the table models with this symbol, two or three colors can be selected from our various trendy colors and combined in a multi-color upholstery. You can find our color charts with the current collection on page page 21 of the catalog.



Dual Headrest

Spa tables with this symbol can be equipped with the new, unique dual headrest. With this version, the face cradles can be swapped between a classic o-shaped and a softer horn-shaped insert.



Multifunctional Headrest

The special headrest holder allows a variety of individual settings thanks to its double-joint system, which can not be achieved with a normal headrest. In conjunction with the separately available head sections, this makes almost every treatment in the head area possible. The following attachments are available:

Crescent headrest

This headrest made of soft, washable PU, is ideal for cosmetic treatments, because the areas of the throat, neck, and shoulders are completely free and can thus be treated comfortably. At the same time, the customer's head is held in a comfortable and stable fashion. Also ideal for permanent makeup and foot care/podiatry!

U-shaped headrest

With washable synthetic leather, soft upholstery. Both headrests can only be used in conjunction with the multifunctional mounting. Ideal for back massages!



Crescent headrest



U-shaped headrest

Table Options



XL Extension

This clever alternative to the conventional headrest allows individual adaptation to each customer: Simply remove the standard headrest and replace it with the XL Extension. This way both slimmer and wider individuals can be treated in a fashion that is ergonomically best for them. This is particularly useful in the massage position because the XL Extension serves as a support surface for the arms. The XL Extension can of course also be adjusted by simply pulling it out. For the Lina, SL XP and SPL Neo treatment beds, the XL Extension is also available with a face cradle! (Not available with soft upholstery!)



Color- XL Extension

The XL extension can of course also come in a color from our current collection, as can the table itself. You can find our color charts at page page 21.



Color Basic

Color casing

A treatment bed with this symbol is also available with the base, in addition to the standard white, in titanium-colored casing..



Casing in
titanium



White standard
Casing

Special coating of the metal parts

A special coating of the metal parts in RAL colors is possible in models with this symbol. The colors black-brown (RAL 8022), white (RAL 9016), and titanium (RAL 9007) are included in the table price.



Spa Ambience Light

Present your spa table in the proper light! This symbol indicates tables with hidden LED bar at the base. The indirect lighting creates an atmospheric ambience. With most tables you can choose from eight different light colors as well as an automatic color change at the push of a button.



Wood Decor

Most of our spa tables are available standard in wenge-pattern or white. For tables with this symbol, you can also select your own favorite decor and before you know it, your table will be a perfect fit for your space! Ask for our current decor palette or visit our website at:

www.gharieni.de/farbpalette-holzdecore

Gharieni standard decors

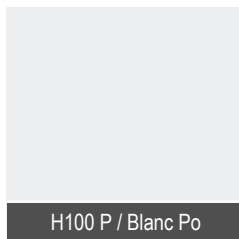
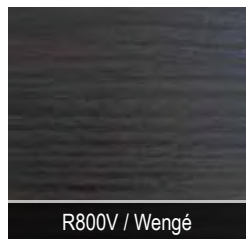

Rotonde

The Rotonde function enables treatment beds to be rotated to the left or right a total 180°. Due to this rotation, the customer can be easily put into the ideal position during treatment. By means of a side lever, the desired position of the table can be determined and also released again. 360° rotation is possible with our hydraulic models. Here the Rotonde function is included for technical reasons.



Castors

Additional castors

Treatment beds with this symbol can be equipped with braked castors. This makes it possible to easily move the table.



Electrically retractable castors

Instead of the mechanical castor mechanism, our spa tables with this symbol are also available with electrically retractable castors. These are controlled via the table's manual switch. That means: Mobility at the push of a button; it doesn't get any easier!



Table Options



Foot Switch

Foot switch Bluetooth®

Now various table models can be equipped with our new Bluetooth® foot control. In addition to operating individual functions, specific key combinations can also be used to call up pre-programmed reclining positions. This makes working even more efficient.



Foot switch wired

Depending on the table model, foot switches with different functions can be used. For certain spa tables, foot switches with memory function are available. These allow you to call up preset table positions in addition to the basic functions such as height or tilt adjustment. With the standard foot switch, only the basic functions can be controlled.

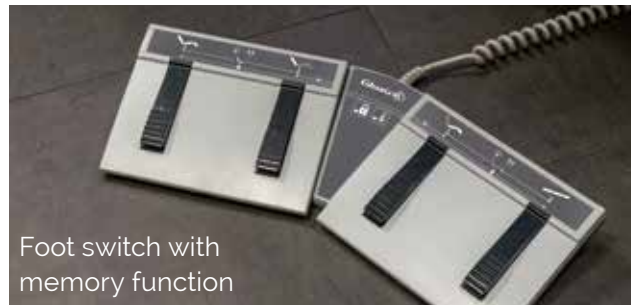

Foot switch with memory function

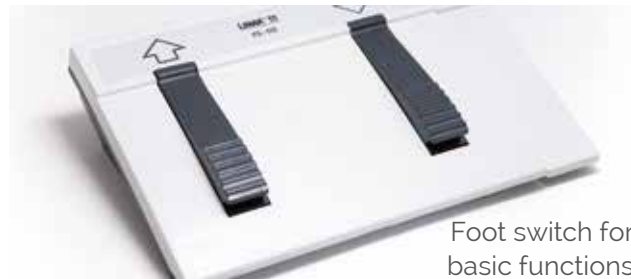

Foot switch for basic functions



Aroma Therapy

Enveloped by pleasant scents during treatment - with the Aroma Therapy option you can turn your treatment into a wellness experience for all the senses.

Depending on the table model, you can release aromas from one or three integrated fragrance chambers at the push of a button. The fragrances can be exchanged as desired.





Multimedia

Multimedia sound system

The sound experience for your table! The built-in audio interface offers a modern interface between many playback devices and your spa table. With the speaker integrated into the table, customers can relax to their own favorite music. At the touch of a button, you can choose between targeted playback on the head area or the entire room.

Connection options: Bluetooth, SD card, USB, AUX, and iPhone.



Gharieni Color Charts

PU upholstery colors



Synthetic leather upholstery colors



Serge Ferrari Color Charts



"Stamskin Top" synthetic leather



Velaa Private Island Maldives





Mind Body Wellness Technologies

Immersive Alpha
Quartz Experience



Gharieni
MLX Quartz

Binaural Vibroacoustics



Gharieni
Welnamis

Advanced Vibroacoustics



Gharieni
RLX Satori

Sound & Haptic Journey



Gharieni
RLX Aurasens

21st Century Wellness Experience



Gharieni
Augmented Massage

Triple-Detox



Gharieni
MLX i³Dome/iDome

Body Rejuvenator



Gharieni
G-Vac

MLX Quartz



Gharieni MLX Quartz

The Ancient art of sand bathing, re-invented!

The luxurious design of the MLX Quartz offers an immersive alpha quartz experience that promotes deep relaxation, metabolism stimulation, and detoxification- for the ultimate 21st century wellness experience.

The warm quartz sand cocoons the body, and feelings of stress melt away as the bed gently inverts and the built-in massage system works to release tension and promote circulation. The MLX Quartz supports pain relief and facilitates immune function, leaving you feeling refreshed, rejuvenated, and with a peaceful mind.

The gentle yet deeply warming effect, enhances the integration of various signature treatments, massages and the use of sand poultices.

Elevate your clients experience with this natural wellness treatment to offer them a much-needed getaway from the stresses of daily life.

Features:

- Made of real wood
- Filled with alpha quartz sand
- Continuously adjustable heating system
- Intense deep relaxation through mild, long-lasting warmth
- Two lifting columns for height and inclination adjustment
- Storage compartment and two drawers in the base
- Integrated facial surface made from soft PU upholstery
- Optional, foldable upholstery overlay for massages
- Standard upholstery color: White. Other colors from our color collection for an additional charge
- Optional scent diffuser (see page 28)
- Optional Dynamic Flow System (see page 30)
- Optionally with salt tiles inserts in the frame



- Height: approx. 65-90 cm
- Length: 217 cm
- Width: 87 cm
- Lifting capacity: 130 kg
- Load capacity of the table surface: 150 kg



MLX Quartz

Standard wood	---
Walnut	---
Salt tiles	---
Illumination for salt tiles	---
Water cushions (6pcs. 2 PU Cover)	---

MLX Quartz

Quartz Varieties

Four varieties of quartz sand filling are available

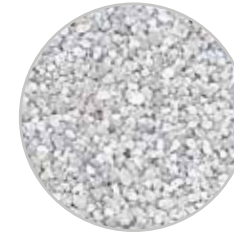

Standard



Gold

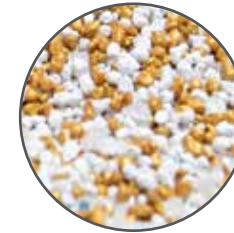

Golden Rain

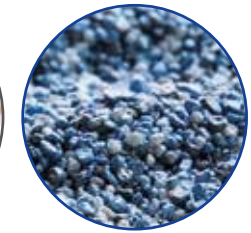

Solid Ocean

Quartz varieties, 180 kg

Standard	included.
Gold	Additional charge -,-
Golden Rain	Additional charge -,-
Solid Ocean	Additional charge -,-



The MLX Quartz table comes equipped with two lifting columns that enable users to adjust the height and inclination of the table. This feature ensures safe and effortless operation, as users can control the table from any position using the integrated desk panels and touch display located on the table frame. The MLX table offers a range of adjustable heights, from 25.6 to 35.4 in, making it ergonomically friendly for the user's back. Furthermore, the table can be inclined to a zero-gravity position, which is particularly effective for massage treatments targeting

the back and shoulder area. Notably, this inclination adjustment creates an ideal stretch that improves spinal health and targets back pain by helping to realign the spine, rehydrate spinal discs, alleviate nerve pressure, relax tense muscles, ease stress, improve joint health and improve flexibility. Beyond its wellness benefits, the warm alpha quartz sand provides a unique experience that can be customized with personalized color mixes for signature treatments. Additionally, the table's appearance can be tailored to specific preferences upon request.

Additions

The following additions can be added to the quartz mixtures (see next page):

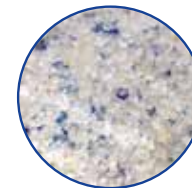

Persian Treasure



Himalayan Touch



Baltic Sunset

Persian Treasure



Persian blue salt is among the rarest rock salts on Earth and is therefore particularly precious. The salt crystals shimmer in harmonizing, relaxing shades of blue – from delicate aquamarine to dark sapphire blue.

The "color of the sky" is associated with several advantageous effects. The color blue is believed to have a calming and rejuvenating impact on both the mind and body, promoting psychological and physical equilibrium. Additionally, the salt's released ions have a beneficial impact on respiratory health. When combined with natural alpha quartz sand, Persian blue salt adds an elegant and exclusive touch to all treatments.

Blue salt	Standard quartz	7,-
Blue salt	Golden Rain or Gold	7,-
Blue salt	Solid Ocean	7,-

Himalayan Touch

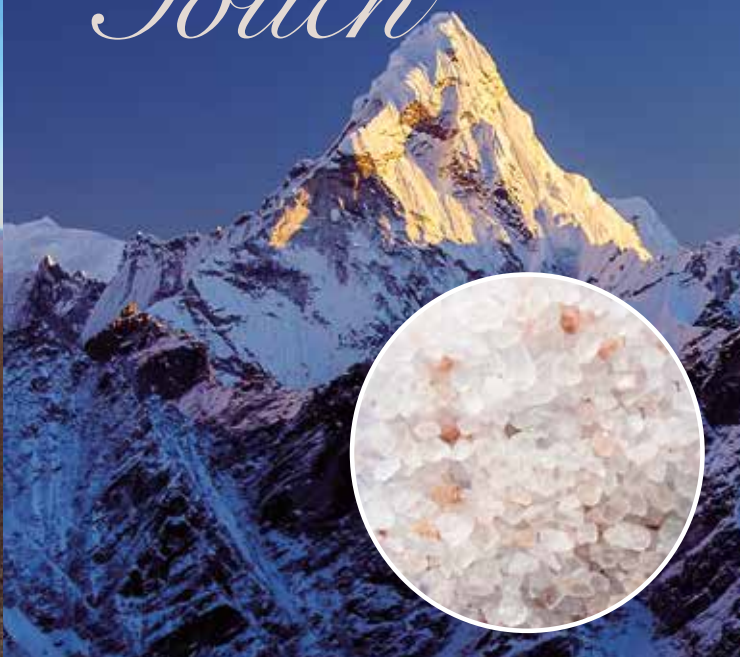

The peaceful microclimate that is often found in mountains, forests, and coastal areas can be simulated in your treatment room by combining Himalayan rock salt and quartz sand. When the quartz salt blend is heated to a desired temperature, salt ions are released, resulting in ionization that enhances air oxygenation. The resulting benefits for both the mind and body include rejuvenation, revitalization, physical relaxation and tension relief, a calming effect, metabolic stimulation, and stimulation of the immune system.

Himalayan salt	Standard quartz	7,-
Himalayan salt	Golden Rain or Gold	7,-
Himalayan salt	Solid Ocean	7,-

Baltic Sunset



The combination of Baltic amber, known as the "Gold from the Baltic Sea," and quartz sand utilizes the calming properties of this unique blend. Amber is recognized for its ability to provide a sense of security, trust, and salvation, and is associated with various benefits, such as spiritual balance, increased energy, regulation of hormones, heightened joyfulness, body detoxification, anti-inflammatory properties (including on the skin), and immune system support. This blend is particularly recommended for a special Signature or Thalasso treatment.

Amber	Standard quartz	7,-
Amber	Golden Rain or Gold	7,-
Amber	Solid Ocean	7,-

MLX Quartz

Aromatherapy Scent Diffuser

This function provides a fragrant enhancement to the experience, to transport the guest to a realm of heavenly scents and ultimate relaxation. With three integrated fragrance chambers that can be easily controlled via the touch display, each chamber can be filled with a different scent, allowing the creation of unique and ethereal fragrance combinations.

Scent diffuser for aroma therapy



The essential oil feature is easily controlled via the integrated, intuitive touch screen.



Salt tiles

Illuminated and heated salt tiles which generate negative ions to purify the air, can be optionally integrated into the sides of the spa table.

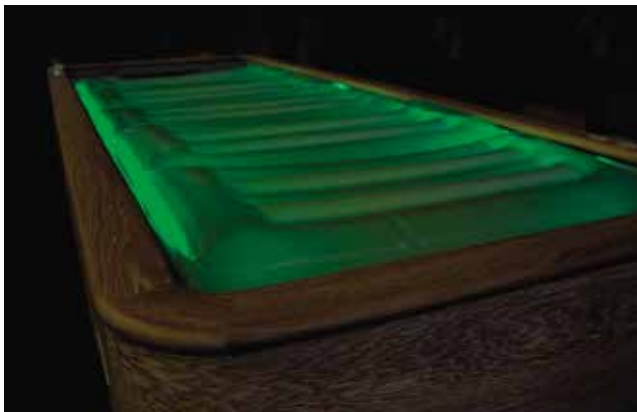

Quartz table or waterbed?

The MLX Quartz has the option of being equipped with water cushions. These can simply be placed on top of the warm quartz sand. 6 cushions will ensure that the water is evenly distributed, providing a warm, stable and supremely comfortable surface.



Optional upholstery overlay

With this upholstery overlay, the MLX Quartz can be turned into a "normal" massage table easily and efficiently. The four-piece upholstery is foldable and can be stored away to save space.



Cushions and covers

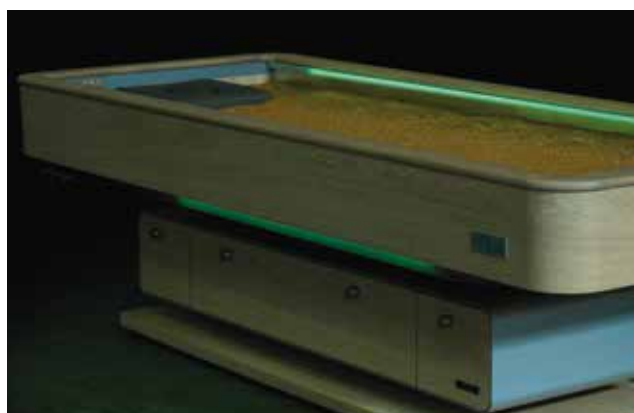

Our exclusive accessory set consists of various cushions and covers. The extensive set allows you to optimize your work perfectly.



Illuminated base

The LED strips under and on the table surface provide light accents in your desired color on the MLX quartz. In addition, they create an atmospheric lighting in your workspace.

Options (more info. after page 14)

- 
Color upholstery:
- PU (white or choco included in price), each color
,-,-
- Synthetic leather standard, per color
,-,-
- Synthetic leather Ferrari Stamskin Top, per color
,-,-
- 
Metal parts in special colors (white, titanium, or dark brown are included in the table price)
,-,-
- 
Other woods and paints
,-,-
- 
Spa Ambience Light: Base with LED lighting
,-,-
- 
Aroma therapy
,-,-

Accessories (see also page page 146)

- Standard upholstery cover, white (Additional color charge, see options)
,-,-
- Maxi accessory set for MLX Quartz consisting of:
- 1 Gharieni quartz stamp heater in same color as the MLX Quartz, filled with Alpha quartz / 6 quartz stamps big additional protective covers / 4 quartz stamps medium additional protective covers / 4 quartz stamps small additional protective covers / 10 oil massage sheets in white or choco / 1 'Dentalax' neck supporting cushion in white or choco / 1 gel ring (gel cushion for nose slot) / 100 nose slot towels / 2 positioning pillows, filled with special sand / 1 shoulder pillow, filled with special sand / 1 Singing bowl medium, 15 cm, 725-775 g, with cushion and mallet / 1 Singing bowl big, 22 cm, 1,5 kg, with cushion and mallet
,-,-

MLX Quartz

Sand in Motion

Dynamic Flow System

The built-in massage feature

The MLX Quartz incorporates the Dynamic Flow System, which features a built-in undulating massage function. Air chambers within the system are pre-set to fill with air and release it, causing the warm quartz sand to move in a pleasant manner. This enables customers to enjoy a soothing back massage, even without the presence of a therapist. When combined with a therapist's massage, this becomes an elevated 360-degree treatment experience. The controlled temperature of the sand warms the body, while the gentle movements from below support the massage being performed from above.

Dynamic Flow System



The Dynamic Flow System...

...moves the quartz sand under the back area in gentle, wavy movements.

Quartz Poultice

The sand poultices are a great addition to the MLX Quartz as they come in various sizes to allow for diverse heat treatments.

Quartz Poultice Warmer

Large, incl. 10 Quartz poultices

small, incl. 10 Quartz poultices



Quartz Poultice Warmer

including 10 quartz poultices

The Quartz Poultice Warmer maintains a consistent temperature for the quartz sand poultices. The heating system can be effortlessly managed from the front panel and an LED indicator displays the temperature status. The real wood frames are designed to match the MLX series, adding to the ambiance of your space. The cover aids in efficient heat storage and the larger model can even serve as a tray for the poultices.

Features:

- Table device for keeping the sand poultices warm
- Also suitable for heating hot-stones
- Made of real wood
- In two sizes
- Filled with alpha quartz sand
- Continuously adjustable heating system
- Including four large, two medium, and four small sand poultices

Quartz Poultice Warmer, large

- Height: approx. 28,5 cm
- Length: 63,5 cm
- Width: 23,5 cm



Quartz Poultice Warmer, small

- Height: approx. 28,5 cm
- Length: 45 cm
- Width: 23,5 cm



Filled with quartz sand

Like the MLX Quartz, the poultice warmer is also filled with alpha quartz sand. This guarantees a uniform and sustainable heat release.



No unnecessary heat loss

The practical cover panel of the device prevents heat loss inside. In addition, it can be used as a practical tray on the large sand poultice warmer.

Cartesiano

Puebla, Mexico





Wellnamis



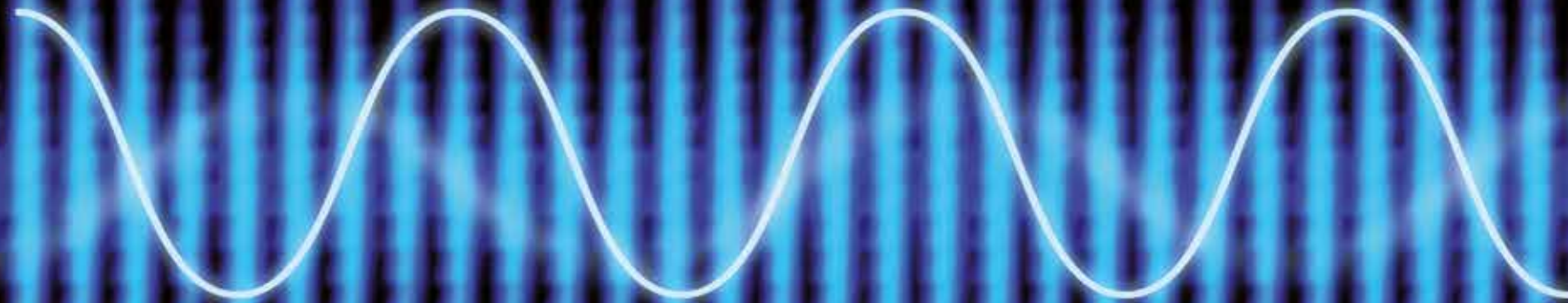

Welnamis - Waves of Wellness for Mind & Body with Binaural Vibroacoustics

Welnamis is an acoustic and vibrational technology that trains the brain to relax and benefit from deep relaxation techniques. Using specific vibrations and binaural audio frequencies, Welnamis makes it possible for even the busiest minds to achieve deep levels of relaxation in one session. Similar to meditation, specific sounds slow down mental activity and vibrational fre-

quencies act specifically on the energy centers of the body. The foundational technology is the Quantum Harmonic audio treatment. It delivers symptom-reducing and resilience-building multilayered programs through stereo headphones. Welnamis can be combined with other spa and wellness treatments. For the pure Welnamis experience no therapist is required.



Audio stimulation

Binaural sounds (with both ears) are a psychoacoustic phenomena that is perceived when two sounds with slightly different frequencies are applied separately to the left and right ear. The brain automatically generates a third frequency, which results from the difference between the two original carrier frequencies. With the help of these frequencies it is now possible to specifically influence the different frequency ranges in the brain, as the neurons automatically try to adapt to the external frequency.

These sound frequencies, when precisely delivered, create synchronizations between the left and the right hemispheres of the brain. This process is called brainwave entrainment.

These binaural sounds are embedded in relaxing, specially composed music and work in a frequency range that is not perceptible to the human ear.

Vibroacoustic stimulation

The second important feature of the Welnamis experience is the technology of pure synchronized sinewaves that are delivered through tactile transducers embedded in the surface of the spa table. Perceived as gentle vibrations which affect the energy centers of your body, this sinewave frequencies multiply and accelerate the brainwave entrainment process.

Welnamis offers a complete experience of impulses from audio and vibrational frequencies to calm the body and mind and bring both into a relaxed state.

Deep relaxation
for busy minds

Enhances mood

Reduces symptoms of stress
and anxiety

Improves conditions
for sleep quality

Supports wellness for the management of chronic stress



The features of the Welnamis are controlled by the intuitive touch display.

Evidence based



MLW Amphibia Welnamis

Spa table incl. Welnamis System



Raffles The Palm Dubai
UAE





RLX Satori



Wellness Lounger

Gharieni RLX Satori Wellness Lounger

Advanced Vibroacoustics

Found in the world's most exclusive wellness centers, clinical health environments, behavioral change clinics, therapeutic & rehabilitation centers and allopathic hospitals, the RLX Satori Wellness Lounger offers a complete natural vibrational and binaural sound treatment, designed to fully synchronize body and mind.

This combination of mind-body stimulation is a powerful and effective tool for changing neural pathways and creating healthy behaviors. Vibroacoustic treatment has been clinically proven to have positive effects on mood states and behavioral change in people recovering from stress, anxiety, sleeping disorders, and addictions, as well as in people looking to reduce stress and increase a calmer state in their lives.

RLX Satori provides a non-invasive delivery of consistent and positive outcomes without medications, supplements, mechanical implements or electrical stimuli.

The luxurious Lounger utilizes proprietary technology that releases specific sound frequencies projected throughout the body, while synchronous binaural sound and music design, sometimes combined with guided meditation, guides brainwave patterns to states of relaxation, meditation, sleep and optimum focus.

The Satori offers a selection of non-verbal and voice-guided (English) programs. Each program is made up of individual sessions.



Features RLX Satori:

- Optional design variants
- Easy-to-clean synthetic leather cover
- Standard upholstery color: dark grey. Other colors from our color collection on demand
- Electrical inclination adjustment
- Heating for RLX Electric lounger surface
- Optional color-matched neck rest

Options



Metal parts in special color
(white, titanium or dark brown are included in the price of the table)

,-,-



- Access height: 42 cm
- Projection length: 190 cm
- Width: 70 cm
- Load capacity of the table surface: 160 kg

Gharieni RLX Satori

The Wellness Lounger

,-,-

An effortless way to improve mental and physical wellbeing

Wellness treatment for symptoms of low-energy, lack of sleep, anxiety and stress

Supports behavioral change including weight reduction & addictive behaviors

Evidence Based

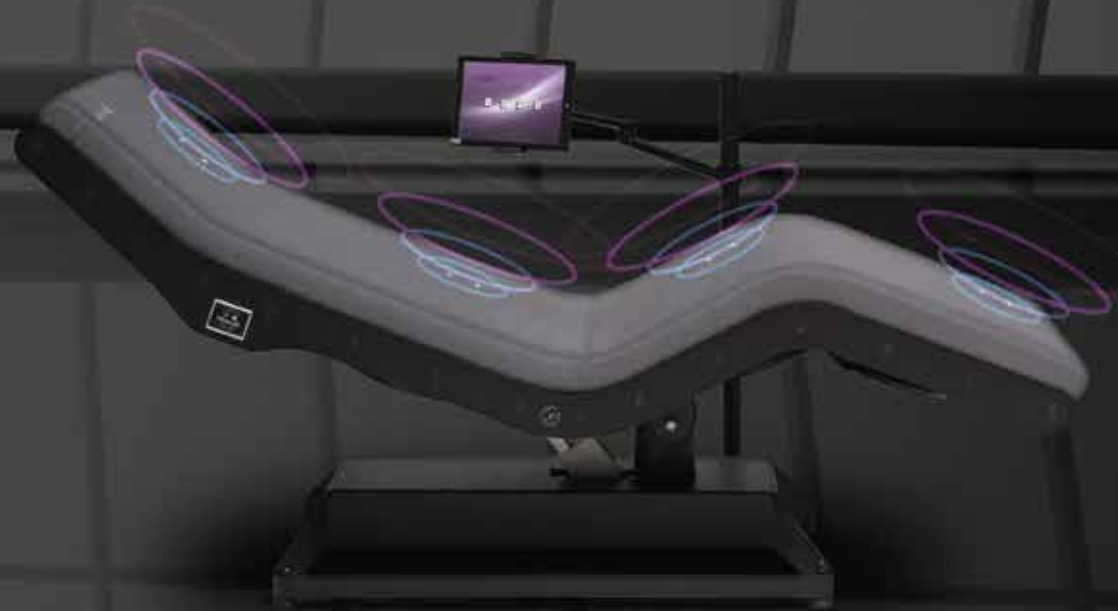

The Technology

All Satori programs utilize audio vibrations, or sine waves, embedded into a multilayered sound technology called Quantum Harmonics™. These sound frequencies, when precisely delivered, create synchronization between the brain's left and right hemispheres.

This hemispheric synchronization results in a quieting of the mind, allowing deep relaxation, meditation, and dreamless sleep to occur.

Through repeated use, this entrainment process allows new neural pathways to be written, promoting lifelong behavior changes.



The Satori Programs

The Satori System offers a selection of nine programs, each with 4-6 sessions available. There are four programs that are non-verbal, and five programs that are voice-guided, all in English.

All of the relaxation and meditation programs guide the brainwaves to alpha and theta levels.

The behavioral change programs utilize the theta brain-wave level, where the conscious mind is shut down, and

the subconscious mind is still active, to deliver guided meditation programs to the subconscious, creating lasting behavioral change.

The sleep and power nap programs are deep delta level programs that help retrain the brain to turn off the thinking mind and achieve states of deep delta sleep.



RLX Aurasens Experience Lounger



Gharieni RLX Aurasens Experience Lounger

Designed to be a distinct and deeply immersive wellbeing experience, this luxurious lounger delivers the magic of music and pulsating haptic sensations, to elevate and transport you to another dimension.

Choose carefully curated experience programs or your favorite music to take you on a journey of altered reality.

The combined auditory and specifically targeted haptic sensors will leave the Wellness seeker wanting to come back again, and again.

RLX Aurasens Experience Lounger offers an ever-expanding catalogue of exclusive composed experiences designed specifically for wellness.

Conversely you can choose to connect your chosen music streaming service for unlimited experiences. Utilising its proprietary artificial intelligence software, the Aurasens lounger elevates your favorite music to an augmented haptic experience.

The ability to create your own soundtrack or offer artist composed experiences is a unique feature to the RLX Aurasens Experience Lounger.

Features RLX:

- Optional design variants
- Easy-to-clean synthetic leather cover
- Standard upholstery color: Dark grey. Other colors from our color collection on demand
- Electrical inclination adjustment
- Optional color-matched neck rest



- Access height: 42 cm
- Projection length: 190 cm
- Width: 70 cm
- Load capacity of the table surface: 160 kg

Options



Metal parts in special color
(white, titanium or dark brown are included in the price of the table)

~--

IN COOPERATION WITH



AURASENS
Beyond music



Gharieni RLX Aurasens

The Experience Lounger

~--

COMPOSED EXPERIENCES ELEMENTS



Recommended for those seeking relief from muscle tension, this experience taps into the vastness of passion to ignite the power from within and boost energy levels. This element brings stimulation and invigoration, representing heat, light, and ultimately, transformation.

The experience lounge replicates the element of fire through unique sounds combined with pleasurable vibrations in varying intensities, moving under the body in pendulum-like movements, to restore balance and facilitate transformation.

'Fire' is a powerful journey that leaves you feeling enlivened and energized and has the ability to transport you to another time and place through sound and vibration. The Fire journey provides a powerful and revitalizing experience that transports the user to another time and place through sound and vibration.



Recommended for those in search of profound relaxation and emotional healing.

This experience allows you to feel the gentle caress of waves, the soothing trickle of raindrops down your back, and the therapeutic properties of the ocean. The element of water has a cleansing and purifying effect always finds its way back to its source

'Water' provides a sensation of bubbles rising and enveloping your limbs, arms, and torso at varying intensities to simulate a feeling of immersion, from the safe-haven of the lounge.

As one basks in this feeling, they can hear the sound of waves lapping against their skin, while the resonating tones of a peaceful gong, help center the mind on the present moment. With the combination of these multi-layered sensory experiences, individuals can achieve a state of tranquility and serenity.



Recommended to enhance balance and physical vitality.

This element facilitates grounding and alleviates mental stress while promoting a heightened sense of embodiment. Percussive rhythms combined with rumbling sensations that cascade down the body like tumbling stones, stimulate multiple parts of the body simultaneously- each with its own unique effect. This immersive experience emulates the very vibrations that underpin the universe, evoking a deep sense of expansion and creation.

The deeply satisfying and enlightening 'Earth' experience offers a holistic journey that engages the entire body.



Recommended for those seeking mental clarity and physical restoration.

Embrace the lightness of being at one with 'air'. Experience yourself as a blade of grass, or a leaf on a branch moving in the breeze. 'Air' provides a lightness of being that is unachievable in daily life.

The mental properties associated with 'Air' will inspire your imagination and creativity whilst the physical sensations stimulate the entire body with particular attention to the acupuncture pressure points in the lower back and limbs.

'Air' is a journey through landscapes of mountains, valleys, deserts and oceans – go there with the Gharieni RLX Experience lounge.

The Technology

The unique patented technology includes 28 transducers that are integrated into the lounger and controlled by the AURASENS module. The position of each transducer in the upholstery is marked with embroidery, to ensure the perfect position for the optimal transmission of sound and vibration.

Wearing noise-canceling headphones, you're completely immersed in the sensations of the Gharieni AURASENS module while lying on the RLX Experience lounger. All programs are controlled with an iPad.



Unlimited and personalized experiences

- Immersive sound and haptic well-being.
- Augmented experience.
- Music and nature's sounds transport you to another place.
- Landscape and dreamscape converge.



Augmented Massage



THE 21ST CENTURY
MASSAGE EXPERIENCE

Gharieni Augmented Massage

The Gharieni Augmented Massage completely redesigns the massage experience, for both therapist and client. Real time sounds, created by the touch of the therapist's hands, turn this wellness experience into a unique and exceptional live performance.

The motion-to-sound medium, groundbreaking in the world of spa and wellness, is an unfiltered expression of human energy and the ultimate NOW experience. This innovative technology transforms every treatment into a bespoke and ever-changing interpretation of a musical score. The sound is alive, closely following the unique gestures of the therapist.

A display guides the therapist throughout the experience, and built-in sensors analyze the position and speed of the therapist's movement in real time, to produce live sound in unison.

The Augmented Massage technology is set to enhance the experience of massage and elevate it to a whole new level. This innovation represents the ultimate merging of human touch aided by Gharieni's Mind/Body Wellness Technologies.

Features:

- Computer-controlled IR sensor
- Bose sound system with 9 speakers
- High quality sensor arm
- Real time monitoring display for easy use
- Stand alone plug and play
 - no additional room installation needed
- Actuators for adjusting the height, back, leg, and foot sections
- Swiveling and lowerable arm supports
- Hand switch with locking feature
- Quilted PU
- Standard upholstery color: white or choco. Other colors from our color collection for an additional charge
- Optional LED lighting strip for base lighting



- Total height: 187 cm - 219 cm
- Height of lying surface: approx. 57 cm - 89 cm
- Length of lying surface: 216 cm
- Total Length: 206 cm
- Width: 85 cm
- Lifting capacity: 250 kg
- Load capacity of the table surface: 300 kg



Augmented Massage

Spa table incl. system



MLX i3Dome

Triple-Detox



Gharieni MLX i³Dome/iDome

Far Infrared (FIR) • Plasma • Light

MLX i³Dome® is a next generation detoxification treatment that integrates three highly effective detox methods into one by combining Far Infrared technology, Plasma, and Light treatment.

Charge your batteries and detox

While the Gharieni FIR-technology supports the metabolism and the perspiration of the body with long-wave infrared rays through the MLX iDome, the additional Plasma- and Light-Technology device (PLT) at the head section provides visible skin rejuvenation and detoxification. Using the three technologies in such a well thought-out combination is much more effective, as all three support and multiply the results of all individual treatments.

No therapist needed

The Gharieni MLX i³Dome works as a stand-alone treatment, where no therapists is required. After the client is positioned on the MLX iDome with the PLT device, no hands are necessary to support the treatment session.

Features:

- Available as iDome with Gharieni FIR technology or i³Dome with FIR technology and Plasma Light Therapy (PLT)
- Dome pneumatically adjustable with 2 gas lifts
- Lying surface height adjustable and inclinable
- Heated lying surface with electric version
- Also available as Static model without lying surface adjustment
- Spacious drawer
- Standard upholstery color: White. Other colors from our Stamskin color collection at extra charge
- Base in white or wenge, optional in other decors
- Including lying surface extension, dentalax, neck cushion, 2 cover cloths each for the dome and the lying surface



Lying surface extension

- Table surface height: approx. 53-83 cm (electric version) 53 cm (static version)
- Length: 225 cm (245 cm with extension)
- Total width: 90 cm
- Width lying surface: 70 cm
- Lifting capacity: 300 kg
- Load capacity of the table surface: 350 kg

MLX iDome	
With electric adjustment	-,-
Static version	-,-
Plasma Light Therapy Device	
Integrated in base	-,-

MLX i3Dome

Triple-Detox

(Far)Infrared

Plasma

Light

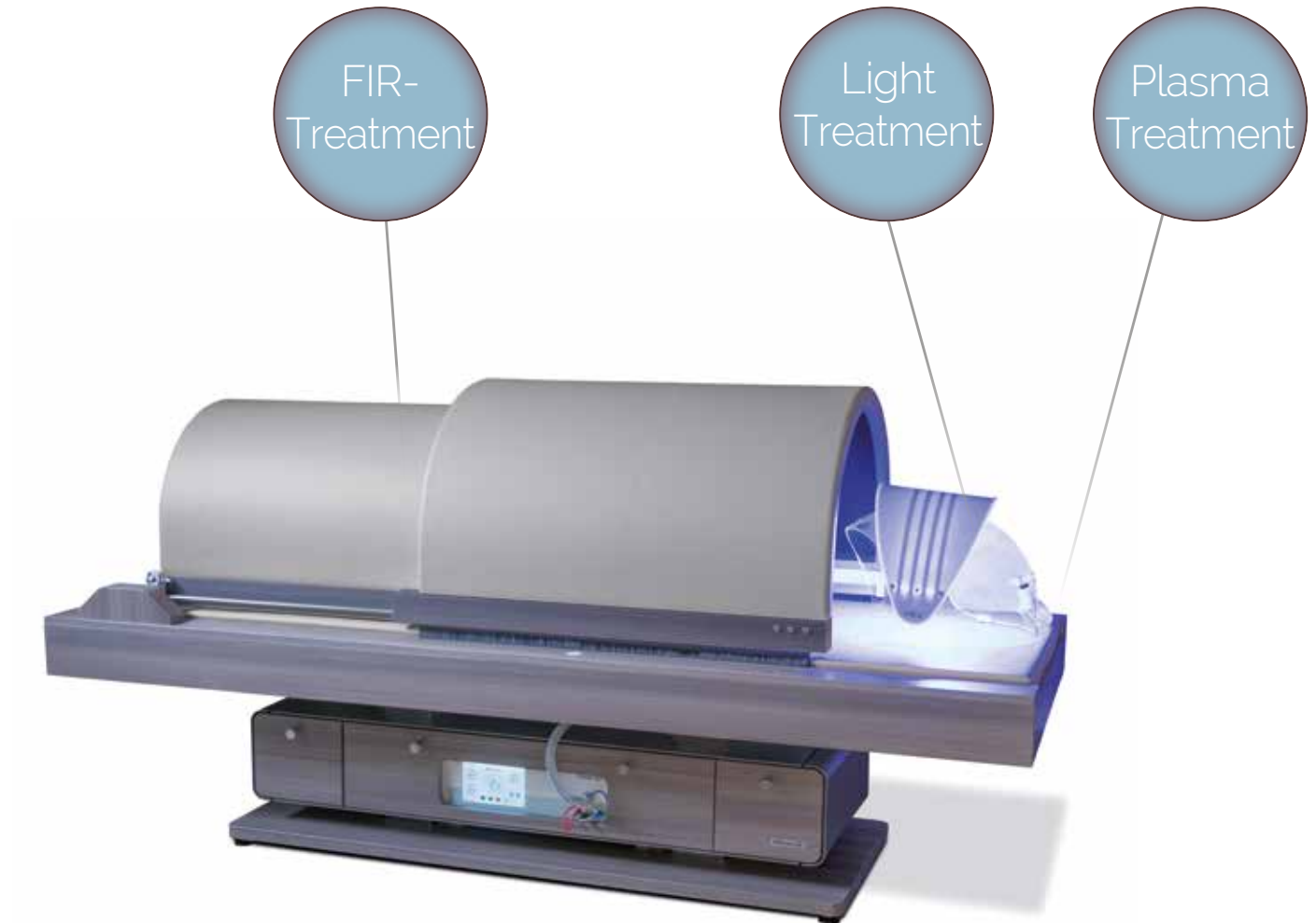

Far Infrared-Treatment

Gharieni FIR technology stimulates the body with far infrared rays

First discovered by scientist Sir William Herschel in 1800, Far Infrared Rays (FIR) are the healthy rays contained in sunlight that are responsible for photosynthesis, the process used by plants to produce energy and without which, there would be no life on earth. Approximately 80% of solar energy is made up of FIR and 60% is between the range of 10-20 microns. Far Infrared Rays are invisible wavelengths of light that are longer than that of visible light.

Benefits include:

- sports recovery
- mental fitness and general wellbeing
- no adverse effects have been reported



Light Treatment

Scientifically proven and effective

Light treatment has been known for a long time and has been successfully used for decades. The effect of the colored light is reinforced by the negative ions.

Applications of red light therapy:

- Increase in collagen formation / collagen synthesis
- Skin repair & renewal (anti-aging)
- Can reduce scar tissue
- Supports wound healing
- Stimulates ATP in cells and increases cellular reproduction

Applications of green light therapy:

- Detoxification
- Antibacterial properties
- Relieves stress symptoms
- Strengthens immune system
- Supports muscle and bone growth
- Aphrodisiac

Applications of blue light therapy:

- Positive influence on Eczema / psoriasis
- Acne
- Antiseptic and antibacterial
- Anti sebum production
- Relieves anxiety
- Strengthens the immune system



Plasma Treatment

Plasma for problem skin, anti-aging and revitalization

Plasma treatment is an innovative method for cosmetic treatments. During the application, clients are exposed to the energy of oxygen (O₂) in the form of applied electrically negatively charged ions.

Benefits include:

- Maintenance of skin health
- Visible improvement of problem skin
- Improved vitality & suppleness
- Positive support of the metabolism in the entire organism

Plasma treatment involves utilizing negative ions gathered from the surrounding environment, as per discoveries in quantum physics. These ions are channeled into a PLT device coated with special materials, where they are combined with Light treatment. By penetrating the skin, the ions stimulate cellular metabolism. Meanwhile, the individual inhales through both the mouth and nose, providing benefits for the entire body, including the organs and muscles.



MLX i3Dome

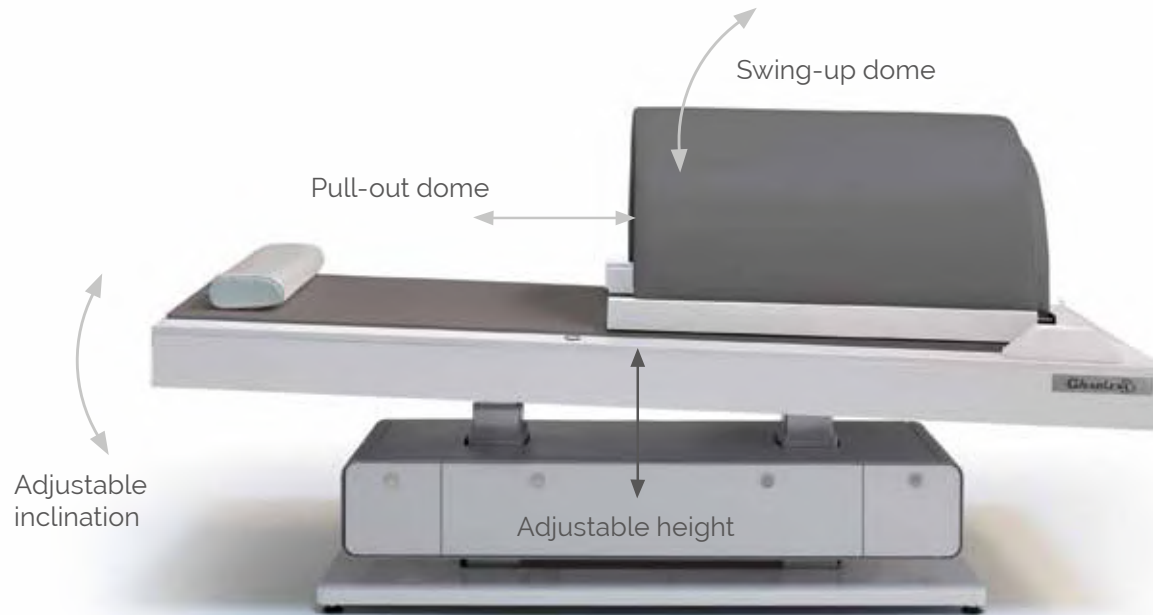

The MLX Dôme has numerous features. By means of its height adjustment, a low entry height of about 57 cm can be achieved

along with a maximum working height of 97 cm. For easy access, the dome can be opened and pushed together manually.

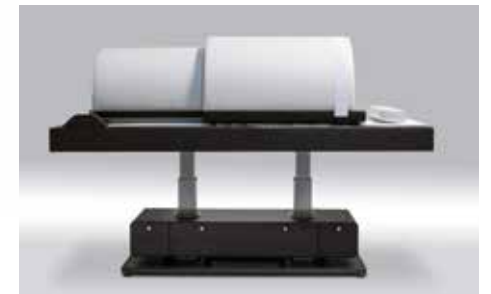



Extension of the lying surface

By utilizing the provided removable upholstery extension, the lying surface can be expanded by 20 cm, enabling tall clients to assume a comfortable reclined position.



Neck cushion included

For improved ergonomics, the MLX i³Dome features separate neck supports, along with a luxuriously cushioned lying surface, ensuring optimal comfort while reclining.



Tension strap for towels





To increase the effect of the IR sauna, a towel can be attached at the open side with a strap. This will keep even more heat inside the dome..



Storage space

On the Gharieni MLX i³Dome (without PLT unit), two drawers and a spacious storage compartment in the base provide plenty of space for towels, work utensils and much more.

Options

-  Color upholstery dome (Ferrari Stamskin)
White included in the price of the table 7,--
-  Metal parts in special color
(anodized, white, titanium or dark brown are included in the price of the table) 7,--
-  Decor surfaces our extended collection (standard collection: see page 17), 7,--
-  Spa Ambience Light: Base with LED lighting 7,--

Accessories

- Cover cloth for dome opening
Art.45860WE, 1 pc. 7,--
- Art.45860WE-10, 10 pcs.
- Cover cloth for lying surface
Art.45861WE, 1 pc. 7,--
- Art.45861WE-10, 10 pcs.

Palazzo Fuggi
Fiuggi, Italy





G-Vac



Gharieni G-Vac

The ultimate in lymphatic and detox wellness

Step into a wellness technology that is set to dramatically improve the way Lymphatic drainage treatments have been conducted in the past. Designed for use in the full area of the lower body, this unique technology, promotes lymphatic reflux, purification, and detox while triggering benefits that support skin and connective tissue tightening, vascular training and the acceleration of regeneration. The result is a contour that looks and feels, refreshed and radiant!

Look Good

- Reduces cellulite
- Reduces hip & thigh circumference
- Reduces spider veins
- Noticeably smoother skin
- Stimulates collagen synthesis

Be Healthy

- Tightens connective tissue
- Improves vascular function
- Enhances cell metabolism
- Optimizes blood circulation
- Stimulates lymphatic drainage

Feel Great

- Increases vitality
- Improves wellbeing
- Noticeable body lightness
- Supports recovery of sore muscles, strains & tears

Features:

- Electrically adjustable backrest
- Touch screen can be equipped with additional card reader
- Certified quality according to ISO / EN
- TÜV-tested, with CE-marking



- Total height: 140 cm
- Length: 220 cm
- Total width: 120 cm
- Width lying surface: 70 cm
- Load capacity of the table surface: 180 kg

Gharieni G-Vac

Complete

,-,-

G-Vac



FIGURE

Lymphatic drainage, detox, skin firming & tightening, anti-cellulite, spider veins



REGENERATION

After intensive sporting activities, competitions, circuit and endurance training, and to optimize performance.



WELLNESS & VITALITY

Lymphatic drainage, Nitric-Oxide release, venous de-congestion, increased vitality and sense of wellbeing



VASCULAR TRAINING

Increase in micro/macro-circulation, capillarization, promotes blood circulation. Great for spider veins, varicose veins, tired, swollen feet and legs (for people with "standing" jobs)



CLINICALLY PROVEN TECHNOLOGY

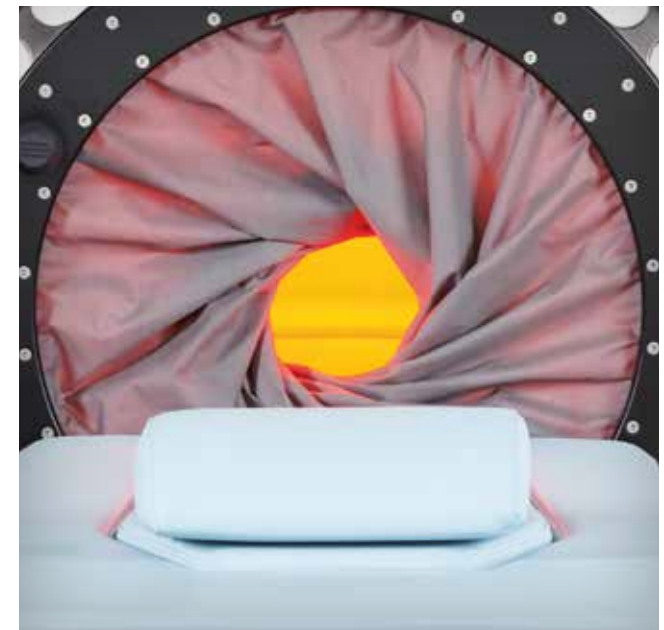

The Gharieni G-Vac combines clinically proven negative pressure wave therapy (Intermittent Vacuum Therapy) with the benefits of compression treatment (mechanical lymphatic drainage, sliding wave massage). Customers find the patented alternation of vacuum and positive pressure extremely pleasant, beneficial and relaxing. For use in the Body & Shape area, the G-Vac is also equipped with a Beautylight module (red light in the area of the near infrared, photo-biostimulation) for additional strengthening of the connective tissue and for firm, smooth and beautiful skin.

Three in one

Vacuum waves, compression and Beautylight at the same time! This is the new top standard in modern full-body cosmetics, figure and health care. More is not possible. The technology is safe and durable, made-in-Germany and TÜV-tested.

HydroSpa



Gharieni
PediSpa Square



Gharieni
PediSpa Compact



Gharieni
PediSpa Curve



Gharieni
Hair Swing



Gharieni
Libra Edge



Gharieni
MLR Wet

PediSpa Square



Gharieni PediSpa Square

More than a foot spa! Whether pedicure, manicure, cosmetics, makeup, or hair care: the PediSpa Square offers a wide range of treatment options thus making it a real all-rounder! Highest demands on functionality, quality, and design make this model with its base made of high-end Corian® the ultimate premium treatment unit.

Features:

- Base made from high-quality Corian®
- Height-adjustable footrest
- Comfortable seat with many adjustment options
- Two possible headrest versions: removable (option) **or** inclinable (standard, included in the price)
- Seat upholstery in two strengths
- Upholstery made from synthetic leather
- Standard upholstery color: White. Other colors from our color collection for an additional charge
- Two armrests selectable
- Optional: higher armrests with integrated tray

5 in 1

PEDICURE
MANICURE
FACIAL
HAIR CARE
MAKEUP



- Seat height: approx. 63-99 cm
- Base length: approx. 142 cm
- Width: max. approx. 76 cm
- Lifting capacity: 130 kg
- Load capacity of the table surface: 150 kg

PediSpa Square

Basic	,-
Armrests (pair) with folding tray	,-
Removable headrest	,-
Pipeless Massage	,-

PediSpa Square



Extremely flexible

The PediSpa Square has a variety of adjustment options that make a treatment comfortable:

In addition to the headrest which swivels forward by 25°, the backrest can be tilted back by up to 75°. The seat is electrical-ly height adjustable from 63-99 cm, tiltable by 14°, and can be

moved 17 cm forward and backward. The footrest can also be easily adjusted at the touch of a button by up to 21 cm in height. The swivel function of the seat ensures easy access – 90° to both the left and right.



Options (more info. after page 14)



- Color upholstery: max. 2 different colors possible
- Synthetic leather standard, per color
- Synthetic leather Ferrari Stamskin Top, per color
- Synthetic leather Ferrari antibacterial coated, per color



- Corian® surfaces - our collection
(White is included in the table price)



Removable headrest

The PediSpa Square is also available with a removable headrest. This equipment version is recommended for all hair treatments.



Manicure bowl + folding tray

Practical options for manicure: The fold-out trays integrated into the armrests, as well as the flexible manicure bowl, make hand and nail care on PediSpa Square child's play.



approx. 10 cm

approx. 5 cm

Exchangeable seat upholstery

The optional Comfort upholstery (pictured left) is made of durable, hygienic PU and is very soft. This allows customers to enjoy their treatments even more relaxed.



Hair care

Care from head to toes! Together with the Hair Swing basin, the PediSpa Square with removable headrest also makes hair care easy.

PediSpa Compact



Gharieni PediSpa Compact

With our PediSpa models, you can not only work perfectly professionally, but the foot bath also becomes a special wellness experience. Because these treatment tables offer exceptionally comfortable seating. The space saver among the PediSpas is the PediSpa Compact, which is permanently installed on the floor and has an integrated water inlet and outlet as well as a pull-out hand shower. Its basin is covered by the frame as soon as the seat is pushed forward. In addition, the little step on the front can be pulled out. Featuring a non-slip surface, customers can comfortably and safely be seated and also "descend" back down again. In addition, the PediSpa Compact is available with two armrests: standard with low armrests or optionally with high armrests, each of which can be equipped with an integrated folding tray.

Features:

- Two-part base
- Seating area completely movable to the rear
- Foot basin made of high quality Corian® securely installed on the floor
- When the seat is pushed forward, the basin is covered by the frame
- Compact construction
- Adjustable backrest
- Two possible headrest versions: removable (option) **or** inclinable (standard, included in the price)
- Height-adjustable footrest
- Upholstery made from synthetic leather
- Standard upholstery color: White. Other colors from our color collection for an additional charge
- Basin with pull-out hand shower, integrated water inlet, and drain
- Optionally with Pipeless Massage
- If there is no connection to the ground, the installation of a drainage pump is possible
- Optionally with a folding tray integrated in the armrest
- Retractable, non-slip step on the front



- Base length (retracted): approx. 80 cm
- Base length (extended): approx. 150 cm
- Overall width including armrests: approx. 86 cm
- Base width: approx. 80 cm



PediSpa Compact

Standard	,-
Armrests (pair) with folding tray	,-
Removable headrest	,-
Drainage pump	,-
Pipeless Massage	,-

PediSpa Compact



Practical in every respect

With this PediSpa, the base and seat can be pushed over the foot basin to save space. The pull-out step makes it easy for customers to take their seats and descend again; and the headrest, which can be tilted forwards by 25°, offers perfect sitting comfort.

The footrest, which can be adjusted up to 21 cm in height, allows for ergonomic working during pedicures. Thanks to the backrest, which can be tilted backwards by up to 75°, the PediSpa Compact is also perfect for use with cosmetic treatments.



Options (more info. after page 14)



- Color upholstery: max. 2 different colors possible
- Synthetic leather standard, per color
- Synthetic leather Ferrari Stamskin Top, per color
- Synthetic leather Ferrari antibacterial coated, per color



Space-saving construction

This foot bath does not take up much space, because by simply moving the seat forward it is covered by the table base. In addition, a pull-out step is integrated into its front.



Removable headrest

The PediSpa Compact is also available with a inclinable headrest, in addition to a removable/retractable headrest. This equipment version is recommended for all hair treatments.



Manicure bowl + folding tray

Optionally available: The fold-out trays integrated into the armrests, as well as the flexible manicure bowl, make hand and nail care on PediSpa Compact child's play.



Height-adjustable footrest

Simply manually adjust the footrest to the desired height and you'll be working ergonomically in no time!

PediSpa Curve



Gharieni PediSpa Curve

This PediSpa model features an impressive dynamic and elegant design, as well as high-quality workmanship. The height-adjustable foot section and the tiltable and removable head section are easy to handle and also make work easier. Made from the best materials, the PediSpa Curve is a real highlight for every spa, whether in the Basic or Comfort equipment version. With optional extras such as heated seats, pipeless foot massage, as well as auto-filling, the PediSpa Curve Comfort meets your customers' highest demands for exceptional treatments.

Features:

PediSpa Curve Basic

- Base partly made from high-quality Corian®
- Compact construction
- Height-adjustable footrest
- Adjustable backrest
- Headrest inclinable and removable
- Fold-out armrests removable
- Upholstery made from synthetic leather
- Optionally with heating
- Standard upholstery color: White. Other colors from our color collection for an additional charge
- With hand shower

PediSpa Curve Comfort

- Details like Basic
- Pipeless foot massage
- Auto-filling



- Base length: approx. 120 cm
- Width including armrests: approx. 80 cm
- Base width: 70 cm

PediSpa Curve

Basic

7,77

Comfort

7,77

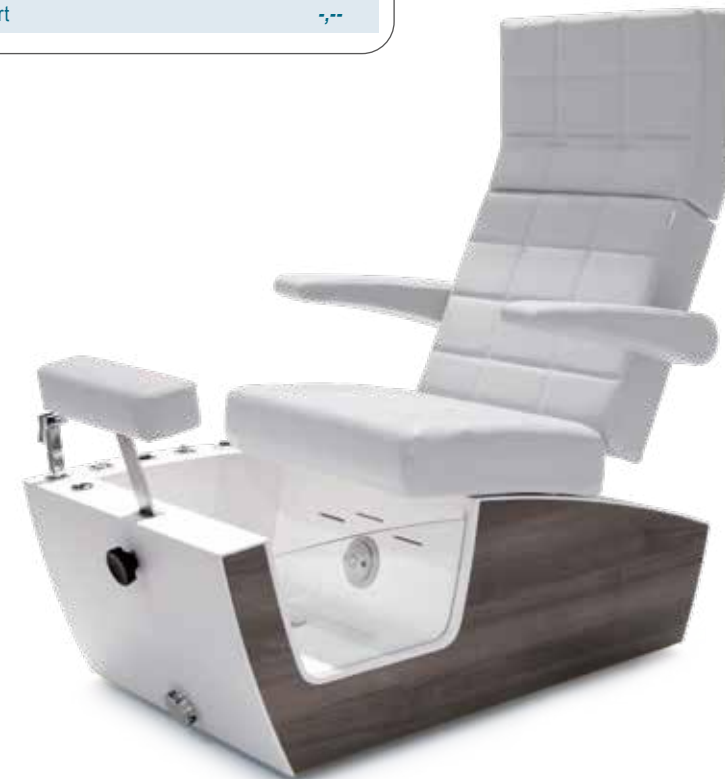

PediSpa Curve



Set-up on request

The seat, which can be moved forwards and backwards a total of approx. 17 cm and the forward-inclinable head section, ensure perfect seating comfort. In addition, the head section can also be removed. This way the PediSpa Curve is perfect for use

with all hair treatments. The armrests swivel to the rear and can also be removed; The backrest can be tilted back by up to 75° – ideal for cosmetic treatments.



Options (more info. after page 14)



- Color upholstery: max. 2 different colors possible
- Synthetic leather standard, per color
- Synthetic leather Ferrari Stamskin Top, per color
- Synthetic leather Ferrari antibacterial coated, per color



- Side decor surfaces our collection, (white is included with the table price)



Easy-to-use fittings

The elegantly designed fittings make it easy to regulate the water temperature and divert the flow of water to the shower head.



High-end wood decor

For an extraordinarily elegant look: Choose the side panel of the base in one of our numerous fine wood decors.



Footrest height-adjustable

The footrest is manually height-adjustable. This puts your customers' feet at the appropriate working height for perfect ergonomic sitting during the pedicure.



Removable head section

The head section of the PediSpa Curve can be both tilted and removed. Thus this table is also well equipped for hair care.



NV Tower
Sofia, Bulgaria



Hair Swing

Washing System Hair Swing

The Hair Swing washing system is a real highlight for all hair care applications. With three articulated elements, the Hair Swing has a particularly wide radius of 120 centimeters. This allows convenient operation of two stations next to each other. The porcelain basin also offers optimal comfort with its tilting mechanism: If the washing system is not in use, it takes up little space thanks to its swivel arm supported by three bearings.

Features:

- Porcelain basin with tilting mechanism for hair washing
- Completely 360° rotatable
- Single-handle faucet row with ceramic sealing
- Hand shower with hose lead-through and shower hose in black, 100/140 cm long
- Foot color: White aluminum
- Basin color: White or black



Hair Swing

White
Black



- Maximum reach 120 cm
- High basins: 94-100 cm depending on the tilt angle



Practical hand shower

The modern, flexible hand shower with its long hose and the practical single-hand faucet allows for optimal hair care..



Flexible articulated arm

After use, the Hair Swing basin can easily be swung aside. This way you have sufficient space for your other treatments.



Libra Edge



Gharieni Libra Edge

This table made of stone-like, yet skin-friendly Corian® is ideal for all wet applications. Because the edge of the heated table surface and the integrated 4-point drain let the water run off even in inclined table position.

The Libra Edge Wet Table is the perfect treatment table for wet treatments, while the Libra Edge with horizontal shower guarantees an exceptional showering experience while lying down. The shower arm can be equipped with two different technologies:

1. With standard shower heads that supply water evenly and continuously. Thus the front table area and the rear area can be controlled independently.
2. With Kohler® technology: These ensure a kind of special water choreography through a temporary, pre-programmed start and stop.

Many functions can also be accessed via an intuitive touch screen display.

Features:

Libra Edge Wet Table

- Base made from Corian®
- Table surface with air/water cushion
- Electrical height and inclination adjustment
- Integrated 4-point water drain for optimum drainage, even in an inclined position
- Optional: Heating system for table surface
- Splash guard to protect the face
- Optional: integrated steam sauna with attachable steam cover

Libra Edge with horizontal shower

- Features such as Libra Edge Wet Table
- Shower arm in two versions: with standard shower heads, with Kohler® technology,
- Intuitive operation via touch screen display
- Splash guard to protect the face
- Optional: LED chromotherapy system
- Optional: Aroma capsule system for hand shower
- Optional: Kohler® Music Soundsystem
- Optional: Integrated steam sauna with steam cover

Libra Edge

With standard horizontal shower

With Kohler® technology



Libra Edge Wet Table

Without horizontal shower



- Table surface height: approx. 63-100 cm
- Height including arm: approx. 190 cm
- Table surface length: approx. 203 cm
- Length including arm: approx. 236 cm
- Width: approx. 85 cm max.
- (Recommended) lifting capacity: 300 kg
- Load capacity of the table surface: 350 kg

Libra Edge

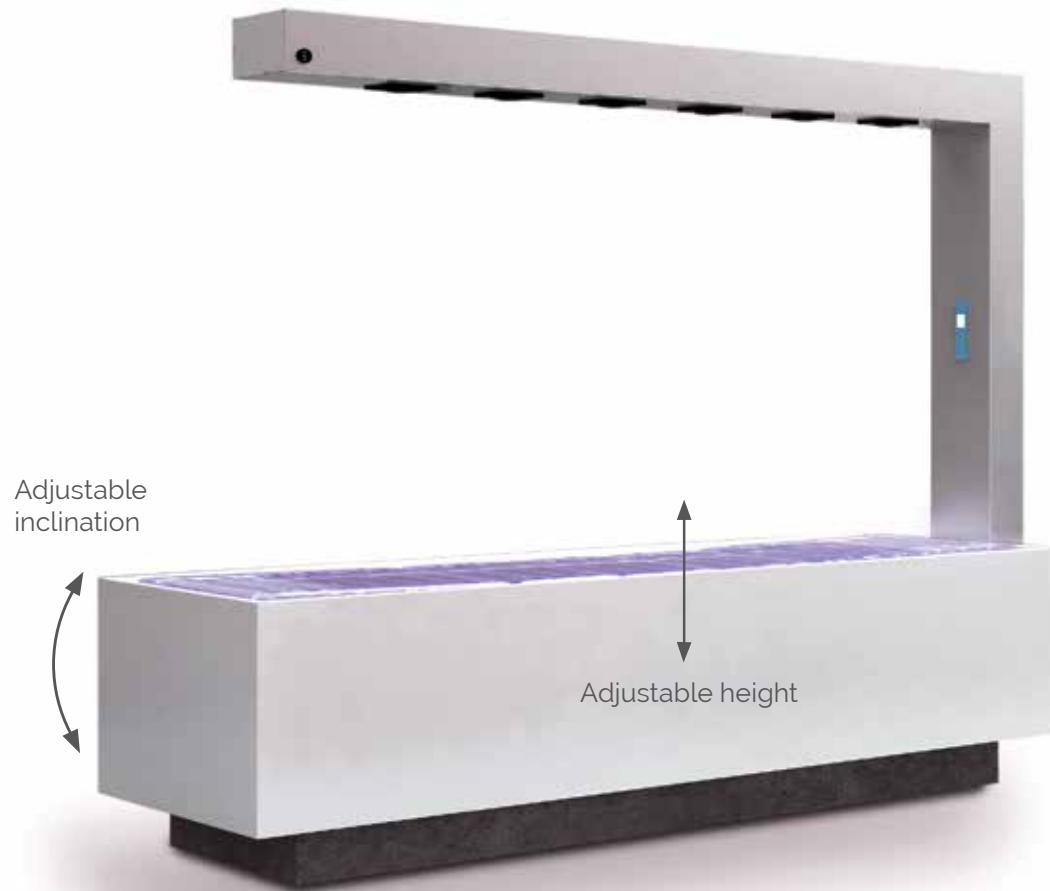

Steam sauna

With the attachable steam cover and steam nozzles integrated into the table surface, the Libra Edge can quickly and easily turn into a steam sauna.



Water or air cushion

The water or air inflatable table cushions offer your customers perfect lying comfort, a relaxing waterbed feeling, and the relaxing sensation of floating on clouds.

Special options

- Heating system for table surface ,--
- Integrated steam sauna with attachable steam cover ,--
- LED chromotherapy system ,--
- Kohler® Music Soundsystem ,--
- Hand shower with aroma capsule system ,--



Face Shield

We offer the Face Shield for those for whom splashing on the face is uncomfortable. In the lying position, it effectively protects the customer's face from unwanted contact with water.



Music and sound system

The optional Kohler® sound system waterproof speakers integrated into the shower arm provide relaxing sounds during treatments.



Aroma capsules

The optional aroma capsule system at the outlet of the hand shower completes the relaxing water experience perfectly: Just insert the aroma capsule and the soothingly aromatic water starts flowing.



LED lighting

The integrated LED lighting bathes the table surface and base with a changing color gradient or individually selectable shade in atmospheric light. This can also be used for chromotherapy.

Accessories

- Face Shield replacement membranes, 6 piece ,--
- Aroma capsules, 10-pack with one variety, 8 different scents to choose ,--

Sofitel Dubai The Obelisk Dubai





MLR Wet



Gharieni MLR Wet

Be it spa treatments in the open air or wet treatments indoors at your spa – with its waterproof coating and the water-resistant materials of the base, the MLR Wet meets exactly these requirements. The purist-elegant spa table offers many electrical adjustment options, such as height, inclination, and back and foot sections. In addition, the MLR Wet is equipped with a Trendelenburg feature and optionally with a locking feature. The upholstery has a face cradle for comfortable prone body treatments. **Important note: for wet and outdoor use, the supplied waterproof cover is required!**

Features:

- Exclusive wet/outdoor table
- Table surface with electrical height, back, leg section, and inclination adjustment
- Including removable, waterproof cover for wet treatments
- Two removable batteries for independent power supply
- Standard upholstery color:
Synthetic leather: White.
Other colors from our color collection for an additional charge



- Height: approx. 57-87 cm
- Length: approx. 203 cm
- Width: max. approx. 80 cm
- Lifting capacity: 300 kg
- Load capacity of the table surface: 350 kg

MLR Wet

Including 2 waterproof covers

-,--



MLR Wet with
waterproof cover

MLR Wet

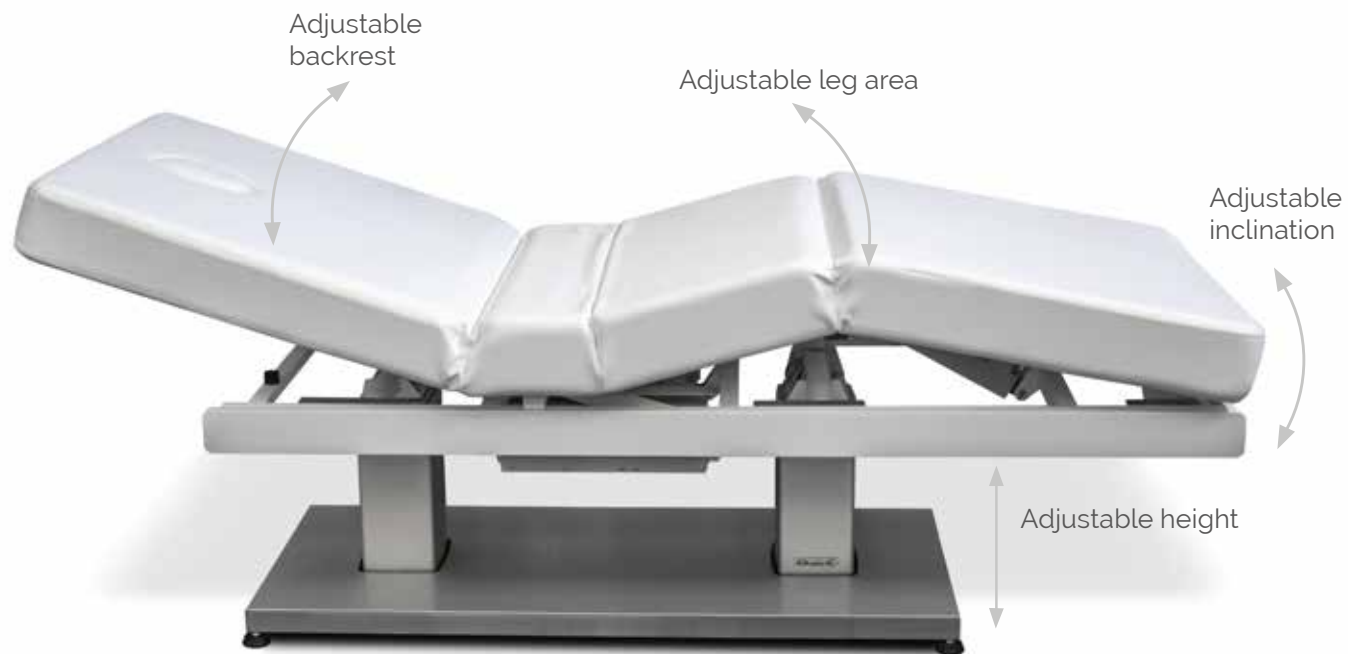

For indoor & outdoor treatments

With its two lifting columns, the MLR Wet can be set at a height of 57-97 cm and the inclination angle of the table surface can be adjusted to +/- 15° to the Trendelenburg position. Also elec-

trically, the back and leg area can be angled at 70° or 25°. Thus, the MLR Wet offers optimal table and working comfort for all wet indoor treatments or outdoor spa treatments.



Options (more info. after page 14)



Color upholstery:

Synthetic leather standard, per color

Synthetic leather Ferrari Stamskin Top, per color

Synthetic leather Ferrari antibacterial coated, per color

7,--
7,--

Accessories (see also page 146)

Waterproof replacement cover

7,--

Replacement battery

7,--

Dentalax neck rest,

7,--

Gel cushions for the face cradle

7,--

Foot protective cover, PVC, transparent

7,--



Waterproof materials

Made with waterproof materials and a removable, waterproof cover, the MLR Wet is the ideal choice for both wet and outdoor treatments.



Trendelenburg position

This zero-gravity table position with low head and elevated foot section allows customers to relax in comfort.



Battery operation

Thanks to the battery integrated into the table, the MLR Wet can also be operated electrically independent of the power supply. It is removable and can easily be exchanged for a supplied second battery.



Waterproof cover

The water-resistant PU cover is skin-friendly, hygienic, tough, and essential for all wet treatments. The cover is available in white or choco..

Spa Tables



Gharieni
MLX Limber series



Gharieni
MLX series



Gharieni
MLR Classic



Gharieni
MLR Select series



Gharieni
MO1 series



Gharieni
MO1 Max



Gharieni
MLW F1 Neo series



Gharieni
MLW Neo series

MLX Limber series



Gharieni MLX Limber

With its numerous adjustment options, the MLX Limber enables unique flexibility – for a new dimension in your treatments. Four different model versions, each available with or without storage space, provide the optimal tool for every need. In the "Flex" top model, the arm supports can be lowered at both ends, which makes the table usable on all sides. The oval-shaped table surface and the extremely narrow base allow for better access to the head/neck and leg areas. Up to six actuators allow extreme positions and thus make the Limber a multifunctional table with unmatched flexibility. The optional storage space in the table base allows for the practical storage of work instruments and equipment such as two medium-sized Hot Cabis.

Features:

- Available in four table surface versions
- Depending on the version, height, inclination, head, back, leg, and/or foot section are electrically adjustable
- Hand switch with locking and memory feature with four preset table positions
- Lowerable arm supports
- Arm supports swivel horizontally
- Inclination head section(s) with face cradle
- Trendelenburg feature
- With PU comfort upholstery in two thicknesses or synthetic leather upholstery
- Standard upholstery color:
Synthetic leather: White. PU: White and Choco
Other colors from our color collection for an additional charge
- Base in white or wenge, optional in other decors
- Doors made of Corian®
- Depending on the model with generous storage space in the base, for example for up to two medium-sized Hot Cabis



- Height: approx. 63-100 cm
- Length: approx. 203 cm
- Width: max. approx. 85 cm
- Lifting capacity: 300 kg
- Load capacity of the table surface: 350 kg



MLX Limber

MLX Limber Classic	,-,-
MLX Limber Pro	,-,-
MLX Limber Flex	,-,-
MLX Limber Podo	,-,-

MLX Limber without storage compartment

MLX Limber Classic	,-,-
MLX Limber Pro	,-,-
MLX Limber Flex	,-,-
MLX Limber Podo	,-,-



MLX Limber with soft upholstery

MLX Limber series



Gharieni Limber Flex

For ultimate maneuverability, the Limber Flex is equipped with lowerable, swiveling arm supports on both the head and foot sides, as well as an inclinable head section with face cradle. This

makes it possible to use this table model from both sides, and completely new treatment positions can be set for a spa table. – Limber Flex: Treatments without limits!





Gharieni Limber Pro

Thanks to its lowerable arm supports and inclinable head section with face cradle, the Limber Pro is also suitable for treat-

ments in prone position. The fold-down foot section provides relief for the feet. In addition, it also allows foot treatments.



MLX Limber series











Gharieni Limber Podo

The Limber Podo is extremely versatile. In addition to the complete functions of a high-class spa table, the Podo version offers laterally swiveling and lowerable footrests. These allow, in ad-

dition to classic foot treatments, the use of a matching mobile PediSpa tub. This way your customers are well taken care of!



Options (more info. after page 14)

-  Soft Upholstery ,-,-
-  Thermo: Three-level heating system with automatic switch-off ,-,-
- Color upholstery:**
-  PU (white or choco included in price), each color ,-,-
-  Synthetic leather standard, per color ,-,-
-  Synthetic leather Ferrari Stamskin Top, per color ,-,-
-  Synthetic leather Ferrari antibacterial coated, per color ,-,-
-  Metal parts in special colors (white, titanium, or dark brown are included in the table price) ,-,-
-  Decor surfaces our extended collection (standard collection: see page 17), ,-,-
-  Foot switch memory function: for controlling the basic functions and the memory positions ,-,-

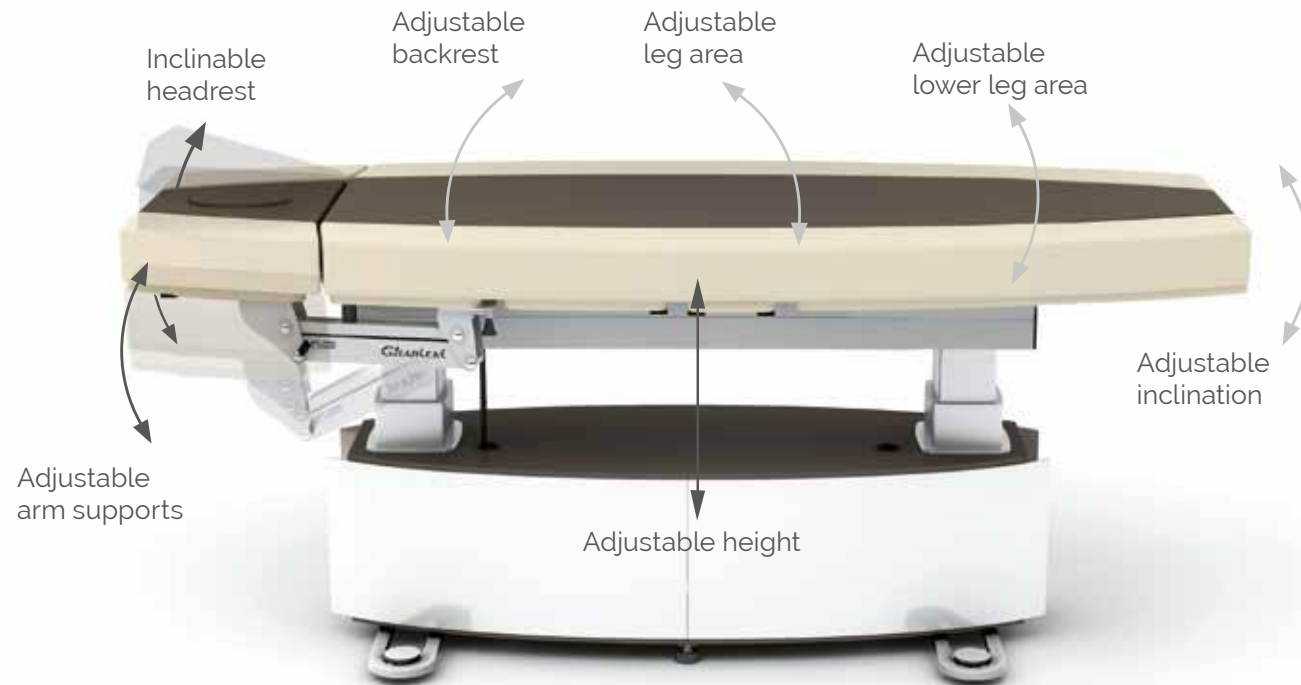

Gharieni Limber Classic

This version is equipped with two lowerable arm supports, a tiltable head section with face cradle, and a full-length table surface. For classic facial and spa treatment.

Accessories (see also page 146)

- Dentalax neck rest, synthetic leather ,-,-
- Dentalax neck rest, PU ,-,-
- Gel cushions for the face cradle ,-,-
- Terrycloth (white or choco) ,-,-



Bergamos Spa Retreat
Friendswood, Texas, USA



MLX



Gharieni MLX

Our exclusive designer table for spa and wellness. Despite the customer-friendly low step height of 58 cm, the table base offers practical storage space. The removable arm supports and covers, for example, and other table accessories can be stowed within reach here.

Four actuators allow for optimal adjustment options, of which up to eight can be stored as memory positions. Removable arm supports and fold-down frame in the head area make the MLX a perfect work tool for professionals. For individual requests, the features of the MLX as well as its "look" can also be customized.

Features:

- Large storage space
- Two removable arm pads
- Face cradle
- Four actuators for electrical adjustment of height, back, leg, and foot sections
- Trendelenburg feature
- Hand switch with locking and memory feature with four preset table positions
- Soft, robust PU upholstery
- Also available in synthetic leather
- Optional: Soft upholstery
- Standard upholstery color:
Synthetic leather: White. PU: White and Choco
Other colors from our color collection for an additional charge
- Base in five standard decors (see page 17), optional in other decors
- Base with two small drawers and a folding compartment
- Frame in the head area folds away, for a better accessibility of face and décolleté



- Height: approx. 58-98 cm
- Length: 203 cm
- Width: 80 cm
- Lifting capacity: 300 kg
- Load capacity of the table surface: 350 kg



MLX

4-actuator



MLX











Exclusive, practical, & comfortable

This exclusively-designed spa table can be optimally adjusted electrically via four actuators. Thus, not only is a customer-friendly step height of 58 cm possible, but also the adjustability of the backrest by approx. 70°, the leg area by about 23°, and the inclination angle of the table surface by about +/- 15°.

Eight storable memory positions also allow the Wellmassage 5D, which is specially-designed for the MLX. Thus, customers experience an innovative, extraordinary massage experience and therapists are able to work effortlessly and in a back-friendly fashion.



Options (more info. after page 14)

-  Soft Upholstery ,-,-
-  Thermo: Three-level heating system with automatic switch-off ,-,-
-  Color upholstery: PU (white or choco included in price), each color ,-,-
-  Multimedia sound system ,-,-
-  Metal parts in special colors (white, titanium, or dark brown are included in the table price) ,-,-
-  Decor surfaces - our extended collection (standard collection: see page 17), ,-,-
-  Foot switch memory function: for controlling the basic functions and the memory positions ,-,-
-  Spa Ambience Light: Base with LED lighting ,-,-

Accessories (see also page 146)

- Dentalax neck rest, PU ,-,-
- Gel cushions for the face cradle ,-,-
- Terrycloth (white, black, macchiato, or choco) ,-,-
- PU protective cover, Art. 49051 ,-,-
- Foot protective cover, PVC, transparent, ,-,-



Trendelenburg feature

In this zero-gravity table position, the head section is particularly low and the foot section is raised. This allows customers to relax very deeply.



Spa table with large storage space

The MLX is equipped with a spacious storage space in its base. It consists of a combination of two drawers and a large folding compartment..



Removable arm support upholstery

Simply remove the upholstery of the arm supports at the height of the head section and fold the frame down – your customer will then be able to lay down their arms comfortably during all prone treatments.



Available as a Wellmassage 5D special edition

With eight pre-set table positions and special treatment steps, high tech & high touch come together to form a treatment for exceptional deep relaxation.

Hotel PACAI
Vilnius, Lithuania





MLR Classic



Gharieni MLR Classic

The purist MLR Classic has – like the MLX designer bed – two strong lifting columns, which permit a wide range of reclining positions. The absence of storage space in the lower area ensures optimal legroom during treatment.

Height, inclination, as well as back and foot sections are electrically adjustable. In addition, the MLR is equipped with a Trendelenburg feature and a locking feature; and of course there is also a face cradle in the rest.

As an additional option, there is a programmable heating system with automatic switch-off as well as a foot switch for controlling the basic functions.

Features:

- Face cradle
- Height, inclination, as well as back and foot areas are electrically adjustable.
- Base made from wood decor
- Metal edge protection at the base
- Trendelenburg feature
- Locking feature
- Robust synthetic leather upholstery
- Optional PU and soft upholstery
- Standard upholstery color:
Synthetic leather: White. PU: White and Choco
Other colors from our color collection for an additional charge
- Base in five standard decors (see page 17), optional in other decors



- Height: 57-97 cm
- Length: 203 cm
- Width: 80 cm
- Lifting capacity: 300 kg
- Load capacity of the table surface: 350 kg

MLR

4-actuator

,-,-



MLR Classic



Clear design, high degree of functionality

The MLR Classic can be optimally adjusted electrically via four actuators. Thus, not only is a low step height of 57 cm possible, but also the adjustability of the backrest by approx. 70°, the leg

area by around 25°, and the inclination angle of the table surface by about +/- 15°. The four-part table surface can thus adapt to almost all treatment requirements.



Edge protection on the base











The high-end edge protection on both ends of the table base prevents unsightly wear and damage to the decor. This keeps the MLR always looking well-maintained.



Trendelenburg position

Customers will find particularly pleasant relaxation in the zero gravity bed position with lowered head and raised feet.

Options (more info. after page 14)

- 
Soft Upholstery
,-,-
- 
Thermo: Three-level heating system with automatic switch-off
,-,-
- 
Color upholstery:
- 
PU (white or choco included in price), each color
,-,-
- 
Synthetic leather standard, per color
,-,-
- 
Synthetic leather Ferrari Stamskin Top, per color
,-,-
- 
Synthetic leather Ferrari antibacterial coated, per color
,-,-
- 
Decor surfaces our extended collection (standard collection: see page 17),
,-,-
- 
Wired foot switch with memory function
,-,-
- 
Bluetooth® foot switch with memory function
,-,-



Extreme legroom

The MLR offers maximum legroom for all treatments thanks to the particularly slim and elegantly designed lifting columns and the absence of storage space in the bed base.



Also as a wet table version

With a water-resistant PU cover and water-resistant base, the MLR is also perfect for all wet and outdoor treatments (for details see page 86).

Accessories (see also page 146)

- 
Dentalax neck rest, synthetic leather
,-,-
- 
Dentalax neck rest, PU
,-,-
- 
Gel cushions for the face cradle
,-,-
- 
Terrycloth (white, black, macchiato, or choco)
,-,-
- 
PU protective cover, Art. 49051
,-,-
- 
Foot protective cover, PVC, transparent,
,-,-

MLR Select series



Gharieni MLR Select

Your very own personal wellness couch. Our Gharieni MLR Select follows this principle with its three different basic variants, "Alu", "Wood", and "Static", each in three upholstery widths. Intentionally, storage space has been omitted here to ensure optimum legroom. With its reduced design, this couch does not need to hide behind its "big sister", the MLX. Two strong lifting columns, lowerable and swiveling arm supports, adjustable head, back and leg sections as well as an optional fold-down foot section make the MLR Select a versatile work tool. In addition, the couch is equipped with a Trendelenburg function and a locking function. Another option is a programmable heating system with automatic switch-off, as well as a foot switch for controlling the basic and memory functions.

Features:

- Three basic versions with wood or aluminum trim or for direct floor mounting
- Height, inclination, as well as back and foot areas are electrically adjustable.
- Swiveling and lowering arm supports
- also available in a pro version with fold-out foot section
- Trendelenburg feature
- Robust PU upholstery in four widths
- Face cradle
- Optional soft upholstery
- Standard upholstery color: White or choco. Other colors from our color collection for an additional charge
- Hand switch with locking and memory feature with four preset table positions
- Optional with scent generator for aroma therapy



- Height: 61-91 cm
- Length: 200 cm
- Width: 76 cm / 85 cm / 92 cm
- Lifting capacity: 300 kg
- Load capacity of the table surface: 350 kg

MLR Select Alu

Small (width: 76 cm)	7,--
Medium (width: 85 cm)	7,--
Large (width: 92 cm)	7,--

Fold-down foot section, manual	7,--
Fold-down foot section, electrical	7,--

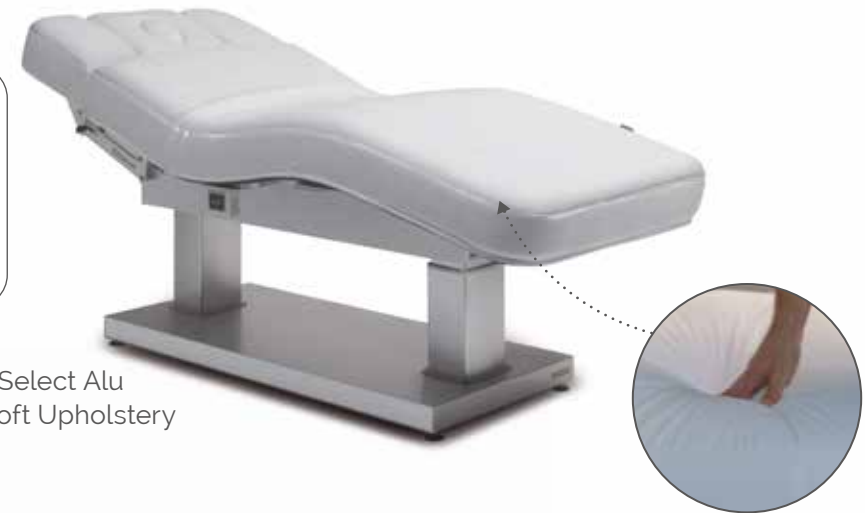

MLR Select Alu
mit Soft Upholstery



MLR Select Wood
with standard upholstery

MLR Select Wood

Small (width: 76 cm)	7,--
Medium (width: 85 cm)	7,--
Large (width: 92 cm)	7,--

Fold-down foot section, manual	7,--
Fold-down foot section, electrical	7,--

MLR Select Static

Small (width: 76 cm)	7,--
Medium (width: 85 cm)	7,--
Large (width: 92 cm)	7,--

Fold-down foot section, manual	7,--
Fold-down foot section, electrical	7,--



MLR Select series



MLR K8

Medium (width: 85 cm)	---
Large (width: 92 cm)	---

Fold-down foot section, manual	---
Fold-down foot section, electrical	---
Warming drawer	---

With the optional warming drawer, compresses, herbal pouches or preparations can be brought to the perfect temperature through six preset heating programs. Internal dimensions: 97 mm (H) x 535 mm (W) x 410mm (D), power, max: 810 W .



Optional lighting (Spa Ambience Light)



Gharieni MLR K8

Equipped with storage compartments and an optional integrated warming drawer, the MLR K8 has the same features as our proven MLR Select models.

Two strong lifting columns, lowerable and swiveling arm supports, adjustable head, back, leg and foot sections as well as an optional fold-down foot section make the MLR K8 a versatile work tool. In addition, the couch is equipped with a Trendelenburg function and a locking function.

Another option is, a programmable heating system with automatic switch-off, as well as a foot switch for controlling the basic and memory functions.

Features:

- Base with storage compartments and optional warming drawer
- Height, inclination, as well as back and foot areas are electrically adjustable.
- Swiveling and lowering arm supports
- also available in a pro version with fold-out foot section
- Trendelenburg feature
- Robust PU upholstery in two widths
- Face cradle
- Optional soft upholstery
- Standard upholstery color: White or choco. Other colors from our color collection for an additional charge
- Base monochrome in five standard decors (see pagepage 17), optionally in two colours and in other decors
- Hand switch with locking and memory feature with four preset table positions
- Optional with scent generator for aroma therapy



- Height: 61-91 cm
- Length: 200 cm
- Width: M 85 cm / L 92 cm
- Lifting capacity: 300 kg
- Load capacity of the table surface: 350 kg

Gharieni MLR Eco

The puristic Gharieni MLR Eco has two lifting columns that allow a wide range of lying positions. The absence of storage space in the lower area ensures optimal legroom during treatment. Four preset and two storable treatment positions as well as control via wired hand control or optional Bluetooth foot control further facilitate daily work. The pleasantly soft PU upholstery is available in the sizes "small" and "medium".

Features:

- Height, leg and back area electrically adjustable
- Arm supports can be lowered
- Robust PU upholstery in two widths
- Soft upholstery optional
- Standard upholstery color: white or choco. other colors from our color collection available at extra charge
- Hand switch with locking and memory feature with four preset table positions
- Optional: Bluetooth foot switch



- Height: 54-92 cm (49-87 cm with flat upholstery)
- Length: 204 cm
- Width: S 76 cm / M 82 cm
- Lifting capacity: 250 kg / 400 kg (High Performance)
- Load capacity of the table surface: 300 kg / 450 kg (High Performance)

MLR Eco

Small (width: 76 cm)	,-,-
Medium (width: 82 cm)	,-,-
High-Performance lifting columns	,-,-

MLR Select series



Gharieni MLR Select Vintage

The unique MLR version with storage space in a retro design is an absolute highlight. The base with exclusive metal-wood look offers extensive storage space for towels and everything else you need for your work.

Like the other members of the MLR Select family, the Vintage has two strong lift columns, lowering and swiveling arm supports, adjustable head, back, leg, and foot sections, and an optional fold-down foot section. In addition, the table is equipped with a Trendelenburg feature and a locking feature.

As an additional option, there is a programmable heating system with automatic switch-off as well as a foot switch for controlling the basic and memory functions.

Features:

- Base with vintage design in metal-wood look (standard monochrome decor)
- Multicolor design possible
- With side panels
- Height, inclination, as well as back and foot areas are electrically adjustable.
- Swiveling and lowering arm supports
- Also available in a pro version with fold-out foot section
- Trendelenburg feature
- Robust PU upholstery in three widths
- Face cradle
- Optional soft upholstery
- Standard upholstery color: White. Other colors from our color collection for an additional charge
- Hand switch with locking and memory feature with four preset table positions
- Optional with scent generator for aroma therapy



- Height: 61-91 cm
- Length: 200 cm
- Width: M 85 cm / L 92 cm
- Lifting capacity: 300 kg
- Load capacity of the table surface: 350 kg

MLR Select Vintage

Medium (width: 85 cm)	,-
Large (width: 92 cm)	,-

Fold-down foot section, manual	,-
Fold-down foot section, electrical	,-



Vintage Trolley

Matching the design of the MLR Select Vintage, the Vintage Trolley with its three drawers and two shelves offers plenty of space for your work instruments.

With its brakable lightweight wheels, it can be positioned wherever you need it..

Vintage Trolley

Single-color	,-
--------------	----

MLR Select series

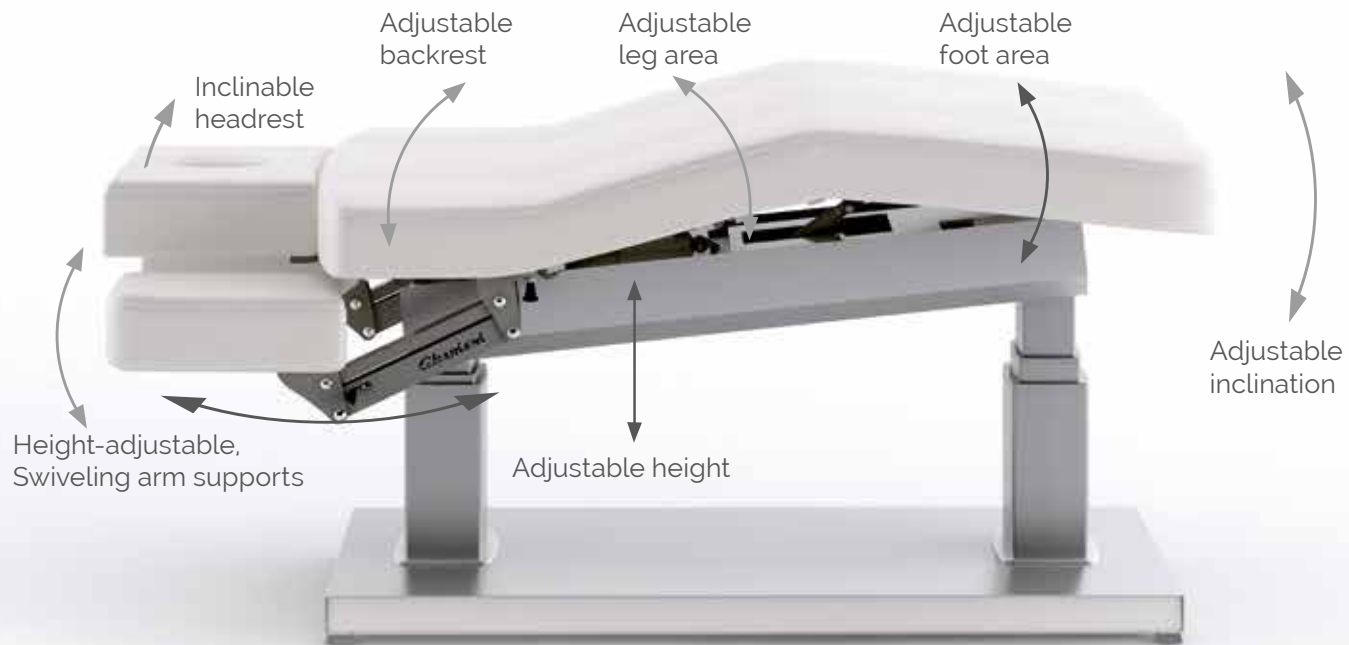









Practical & Versatile

Do not be fooled by the simplified design of our MLR Select! In terms of adjustability, versatility, and ergonomics, it also meets the highest demands. The head section can be tilted by $\pm 30^\circ$. With two lifting columns, the height can be adjusted electrically,

the back and leg sections can be adjusted by 70° or 30° , and the arm supports can be lowered by approx. 15 cm. The inclination of the table surface can be adjusted by $\pm 15^\circ$.

Options (more info. after page 14)

-  Soft Upholstery ---
-  Thermo: Three-level heating system with automatic switch-off ---
-  Color upholstery: PU (white or choco included in price), each color ---
-  Metal parts in special colors (white, titanium, or dark brown are included in the table price) ---
-  Decor surfaces our extended collection (standard collection: see page 17), ---
-  Dual headrest ---
-  Wired foot switch with memory function
Bluetooth® foot switch with memory function ---
-  Base with white LED illumination (only for MLR K8) ---
-  Aroma Therapy ---

Accessories (see also page 146)

- Dentalax neck rest, PU ---
- Roll holder 1 paper roll ---
- Gel cushions for the face cradle ---
- Terrycloth (white, black, macchiato, or choco) ---
- Foot protective cover, PVC, transparent, ---
- Double-sided (magnifying) lamp mount ---
- LED Magnifying Lamp "Circle" ---
- PU protective cover, Art. 49051 ---



Fold-down foot section

The optionally available fold-down foot section not only facilitates treatment of the feet; but also allows their relaxed, natural position with massages in the prone position.



Trendelenburg position

Customers will find particularly deeper relaxation in the zero gravity bed position with lowered head and raised feet.



Swiveling arm supports

The swiveling arm supports give your treatments the necessary freedom: Simply swivel them backwards and you're able to "freely" work on the head, neck, and décolleté area. The pads can be locked in four positions.



Holder for magnifying lamp

A practical option is the retractable magnifying lamp holder made of stainless steel. It was developed for the "Circle" LED magnifying lamp and simply disappears under the bed surface when not in use.

Aesthetic Solutions Training Center Relegem, Belgium





MO1 Evo Neo series



Gharieni MO1 Evo Neo

Our MO1 Evo Neo has an extremely low access height from 50 cm. This table allows even very short or physically restricted customers comfortable and convenient access. The arm supports can be electrically lowered and swiveled on request (exception: the MO1 Evo Neo with removable headrest). The optional storage space in the base is flexible and configurable. This way, Hot/Cool Cabis can be integrated on the head and/or foot side. Three table surface versions ensure individual adaptability. Whether it's standard/soft upholstery or full-length table surface with attachable headrest (without arm supports) – simply choose the table that best suits your needs! Optionally, the MO1 can even be equipped with Breast Contouring System. This ensures that for women, the chest area is relieved in the prone position.

Of course, all models can also be individually configured for upholstery color and basic decor. Ask for our current color and decor patterns!

Features:

- Extremely low access height of 50 cm
- Up to six actuators for adjusting the height, back, leg, and foot sections and optionally for the arm supports as well
- Swiveling arm supports (not on the MO1 with removable headrest)
- Hand switch with locking and memory feature with four preset table positions
- Quilted PU upholstery in three widths
- Three available upholstery versions
- Optional storage space in the base (open or closed)
- Mechanical (optionally electrical) retractable castors
- Standard upholstery color: white or choco. Other colors from our color collection for an additional charge
- Base in five standard decors (see page 17), optional in other decors
- Optional LED lighting strip for base lighting
- Bracket for attaching a (magnifying) lamp optional
- Optional with scent diffuser for aroma therapy



- Height: 50-82 cm
- Length: 205 cm
- Width: S 76 cm / M 85 cm / L 92 cm
- Lifting capacity: 250 kg
- Load capacity of the table surface: 300 kg



MO1 Evo Neo with standard upholstery

MO1 Evo Neo

Small (width: 76 cm)	7,77
Medium (width: 85 cm)	7,77
Large (width: 92 cm)	7,77

Integrated storage space	7,77
(Magnifying) lamp holder on both sides	7,77
Breast Contouring System	7,77



MO1 Evo Neo with soft upholstery



MO1 Evo Neo with removable headrest (without arm supports!)

MO1 Evo Neo series



Extremely low access height

With a height adjustability of 50-82 cm, the MO1 Evo Neo is the ideal table model, even for short or physically restricted customers; because the minimum height of 50 cm makes it easier to get in and out of the table. In addition, the MO1 Evo Neo offers optimal adjustability. Thus, the head section can be tilted by +

60°/-35° and the arm supports can optionally be electrically lowered at the push of a button. The backrest can be set up to 70° and the leg section up to 20°. And for "your" perfect table model, configure the MO1 Evo Neo with a soft, standard upholstery, or a full-length upholstery with a clip-on headrest.





Integrated Hot/Cool Cabi

Integrated compartments in the MO1 Evo Neo on the head and/or foot side of the table base allow Hot and Cool Cabis to be stored. It's a great way to work and your workspace will always be tidy.



Swiveling arm supports

If you need a lot of space for the facial, you don't necessarily have to go without arm supports. The swiveling arm supports give you the necessary free space. Simply swivel them backwards and you're ready to "freely" work on the head, neck, or décolleté area.



Optional: Holder for (magnifying) lamps













The extendable (magnifying) lamp holder made of stainless steel is completely new. When not in use, it simply disappears under the table – a feature no other manufacturer offers. The matching Flex LED magnifying lamp allows for precision while working.



Optional: Aroma therapy

Wellness with all the senses: Immerse your customers into a world of soothing scents during treatment. Your treatment will be a fragrant experience thanks to the integrated scent diffuser.

Options (more info. after page 14)

	Soft Upholstery	,-,-
	Electrically lowerable arm supports (swiveling)	,-,-
	Thermo: Three-level heating system with automatic switch-off	,-,-
	Vibro-Wellness: gently pulsating vibration system with many adjustment options	,-,-
	Color upholstery: PU (white or choco included in price), each color	,-,-
	Multimedia sound system	,-,-
	Metal parts in special colors (white, titanium, or dark brown are included in the table price)	,-,-
	Decor surfaces: our extended collection (standard collection: see page 17),	,-,-
	Dual headrest	,-,-
	Electrically retractable castors	,-,-
	Wired foot switch with memory function Bluetooth® foot switch with memory function	,-,-
	Spa Ambience Light: Base with LED lighting	,-,-
	Aroma Therapy	,-,-

Accessories (see also page 146)

Double-sided (magnifying) lamp mount	,-,-
LED Magnifying Lamp "Circle"	,-,-
Dentalax neck rest, synthetic leather	,-,-
Dentalax neck rest, PU	,-,-
Terrycloth (white, black, macchiato, or choco)	,-,-
Foot protective cover, PVC, transparent,	,-,-

MO1 Max



Gharieni MO1 Max

The practically designed spa table Gharieni MO1 Max offers perfect lying and working equally. The special feature: the compact base of the table moves upwards with the lying surface and can be equipped with normal storage compartments as well as -optional- with a warming drawer. This ensures both optimal leg-room and easy access to your work utensils during treatment. Four preset and two storable treatment positions as well as control via wired hand switch or optional Bluetooth foot switch additionally make daily work easier. The pleasantly soft PU upholstery is available in the sizes "Small" and "Medium".

Features:

- Base with storage compartments and optional warming drawer
- Height, leg and back area electrically adjustable
- Arm supports can be lowered
- Robust PU upholstery in two widths
- Soft upholstery optional
- Also available with lower flat upholstery
- Standard upholstery color: white or choco. other colors from our color collection available at extra charge
- Base in five standard decors (see pagepage 17), optional in other decors
- Hand switch with locking and memory feature with four preset table positions
- Automatic safety lock after 30 minutes
- Optional: Bluetooth foot switch
- Optional with Breast Contouring System
- Optional with fragrance generator (aroma therapy)
- Also available with High Performance lifting columns with approx. 60% more lifting force and 25% higher speed



MO1 Max with standard upholstery



- Height: 54-92 cm (49-87 cm with flat upholstery)
- Length: 204 cm
- Width: S 76 cm / M 82 cm
- Lifting capacity: 250 kg / 400 kg (High Performance)
- Load capacity of the table surface: 300 kg / 450 kg (High Performance)

MO1 Max

Small (width: 76 cm)	,-,-
Medium (width: 82 cm)	,-,-
High-Performance lifting columns	,-,-
Warming drawer	,-,-
Breast Contouring System	,-,-

MO1 Max



Storage space and legroom

The functional MO1 Max has a large storage space that can be adjusted in height with the lying surface. In addition, the MO1 Max offers extensive adjustment options. The headrest can be

tilted by +60°/-35° and the armrests can be lowered by means of a gas pressure spring. The backrest can be adjusted up to 70° and the leg section up to 20°.



Lift-up storage space

The special feature of the MO1 Max: The storage compartments are located directly under the lying surface and are lifted up with it. This means they are easily accessible at all times..

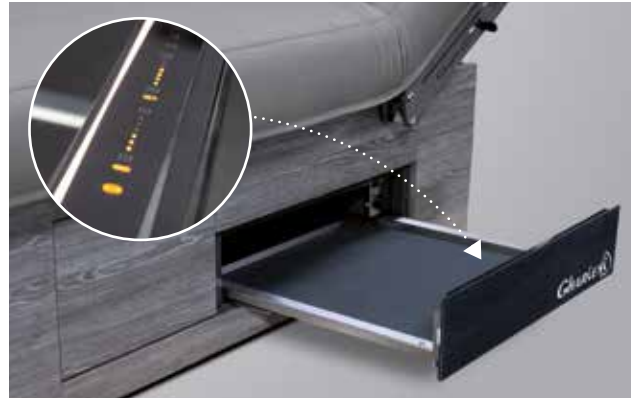

Warming drawer

With the optional warming drawer, compresses, herbal pouches or preparations can be brought to the perfect temperature through six preset heating programs. Internal dimensions: 97 mm (H) x 535 mm (W) x 410mm (D), power, max: 810 W



Spa Ambience Light











The hidden LED strip at the base of the couch adds a light accent in your desired color to the MO1 Max and provides atmospheric lighting in your treatment room.



Integrated Hot Cabi

The storage compartment in the base of the MO1 Max treatment table allows you to store a small Hot Cabi. This allows you to work in a particularly practical way and your treatment room is always tidy.

Options

-  Soft Upholstery ,--
-  Thermo: Three-level heating system with automatic switch-off ,--
-  Color upholstery:
PU (white or choco included in price), each color ,--
-  Metal parts in special colors (white, titanium, or dark brown are included in the table price) ,--
-  Decor surfaces our extended collection (standard collection: see page 17, ,--
-  Dual headrest ,--
-  Manually retractable castors ,--
-  Bluetooth Foot switch with memory function ,--
-  Spa Ambience Light: Base with LED lighting ,--
-  Aroma Therapy ,--

Accessories

- Dentalax neck rest, PU ,--
- Gel cushions for the face cradle ,--
- Terrycloth (white, black, macchiato, or choco) ,--
- Foot protective cover, PVC, transparent, ,--
- Double-sided (magnifying) lamp mount ,--
- LED Magnifying Lamp "Circle" ,--
- PU protective cover, Art. 49051 ,--

Château Des Père Piré-Chancé, France

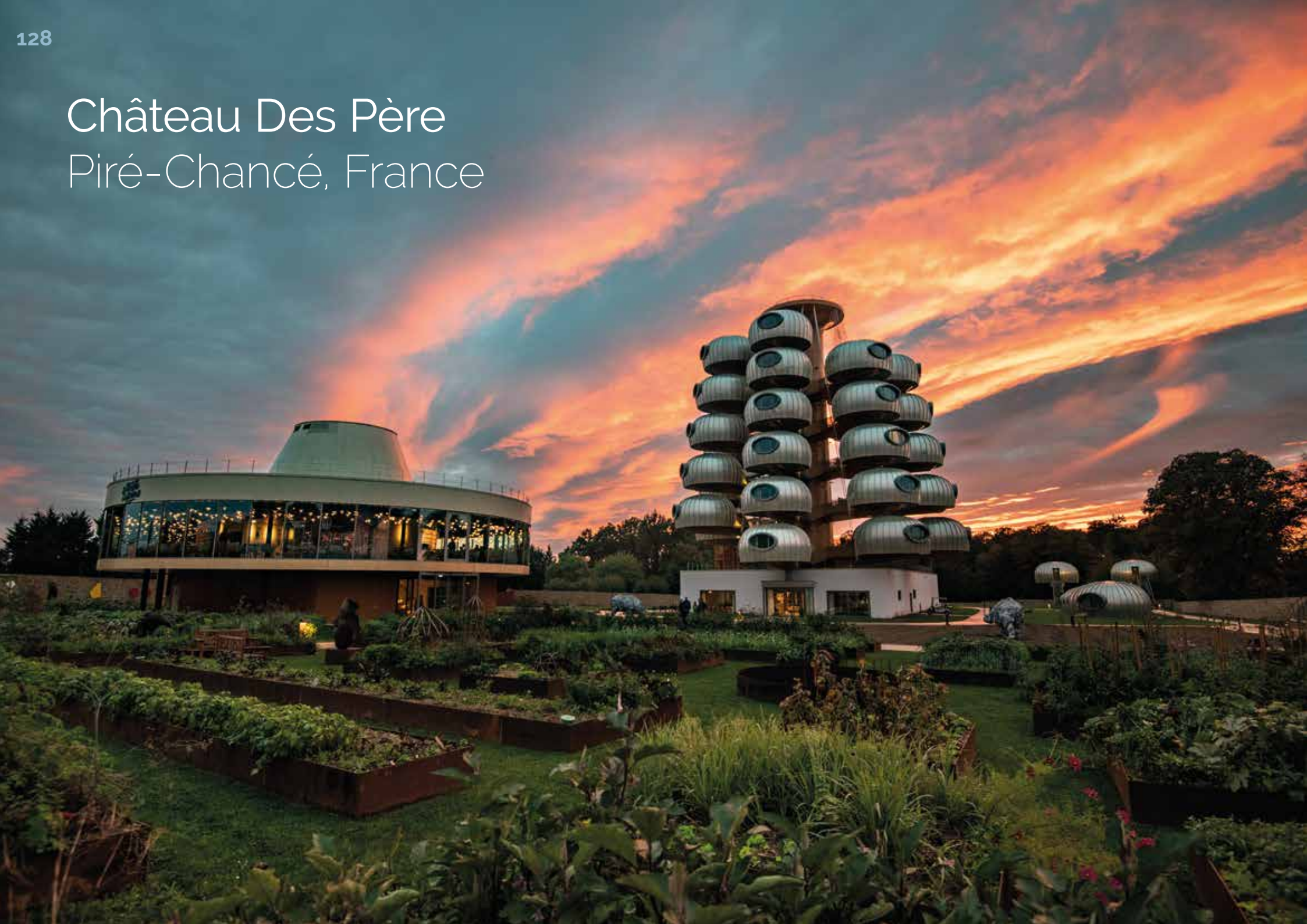



Photos: © Château Des Pères, Piré-Chance/Olivier Marie

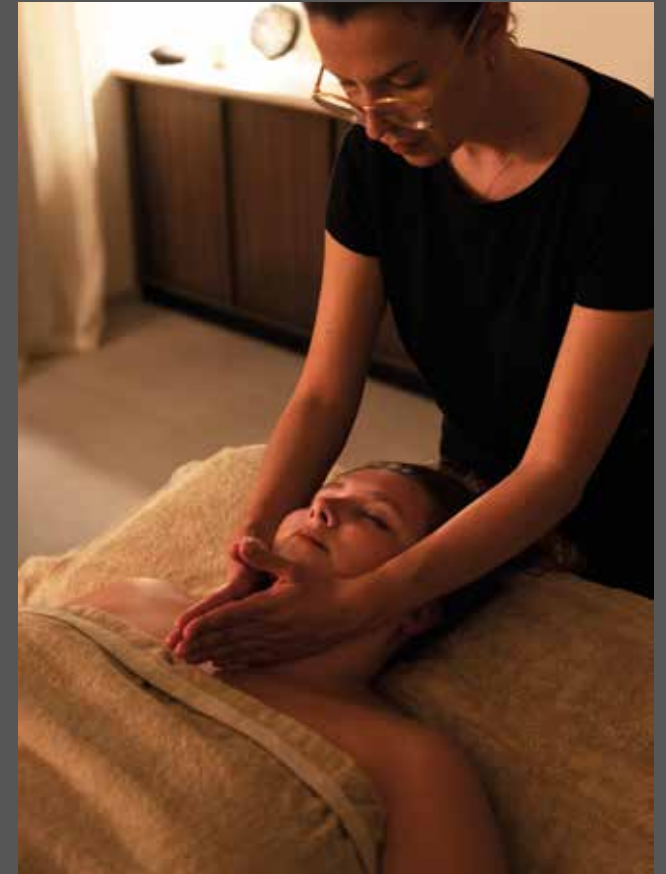

MLW F1 Neo series



Gharieni MLW F1 Neo

The spa table with a special design! The advancement of the MLW Neo has a narrow base, is just 57 cm wide, and features specially curved front ends. These features allow more foot and legroom, making it easier to work on massages and cosmetic treatments. The comfortable full-length upholstery is available in two thicknesses, offering exceptional comfort for every need – even for longer treatment sessions.

A particular highlight is that the wood side panels can be replaced with new ones if necessary. This way you can always adapt the table to your personal ambience.

Features:

- Narrow base trim and gently curved front ends for more legroom
- Configurable equipment
- Exchangeable side wood decor casing
- Up to six actuators for adjusting the height, back, leg, and foot sections and optionally for the arm supports as well
- Hand switch with locking and memory feature with four preset table positions
- Lowerable and swiveling arm supports
- Head section +/- 30° tiltable
- Full-length molded PU upholstery with memory foam in three widths
- Standard upholstery color: white or choco. Other colors from our color collection for an additional charge
- Base in five standard decors (see page 17), optional in other decors
- Mechanically retractable castors



- Height: 58-91 cm
- Length: 203 cm
- Width: S 76 cm / M 85 cm / L 92 cm
- Lifting capacity: 250 kg
- Load capacity of the table surface: 300 kg

MLW F1 Neo

Small (width: 76 cm)



Medium (width: 85 cm)



Large (width: 92 cm)



MLW F1 Neo with standard upholstery



MLW F1 Neo with soft upholstery

MLW F1 Neo series

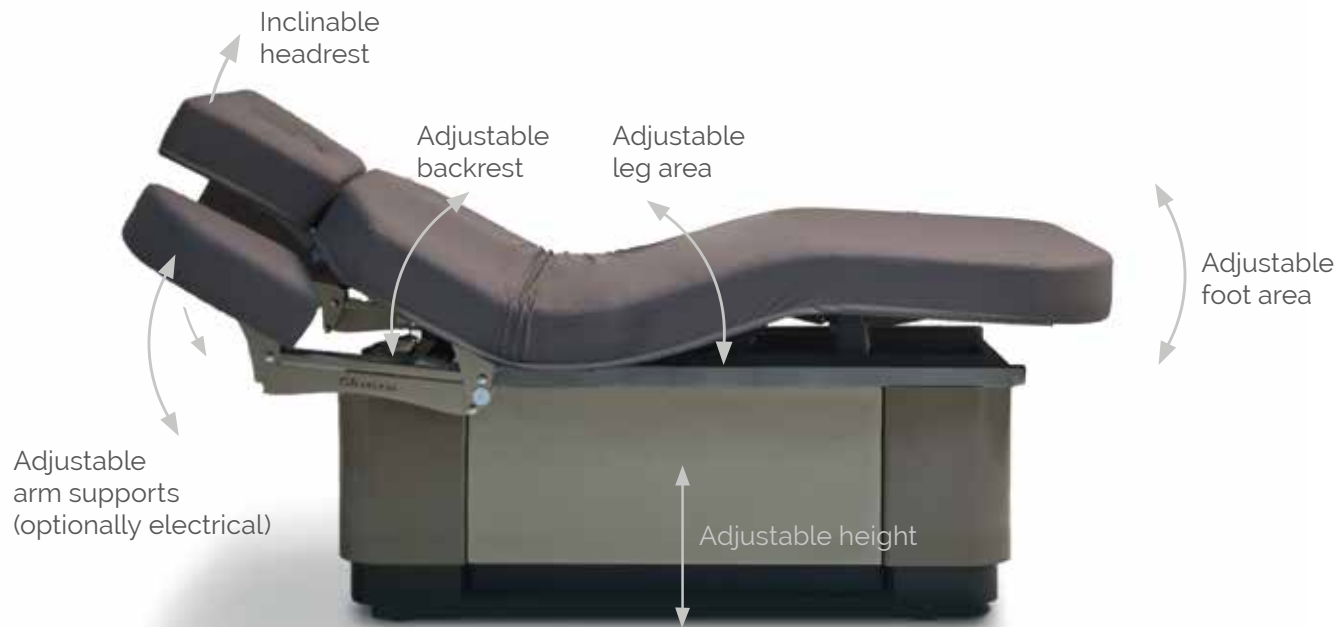

More comfort with six actuators

Our size M and L MLW F1 Neo models are now also available with six actuators. For more comfort, the arm supports – in addition to height, back, leg, and foot area adjustment – can also be controlled synchronously. In addition to direct settings via push-buttons on the arm supports themselves, their setting can be

conveniently saved using the memory functions. This allows the F1 to be moved to the programmed positions with a single push of a button. The table surface can be adjusted from 58-91 cm in height, the backrest by about 70°, the leg area by about 25°, and the foot by up to 18°. The head section can be tilted by +/- 30°.





Swiveling arm supports

If you need a lot of space for the facial, you don't necessarily have to go without arm supports. The swiveling arm supports give you the necessary free space. Simply swivel them backwards and you're able to "freely" work on the head, neck, and in the décolleté area.

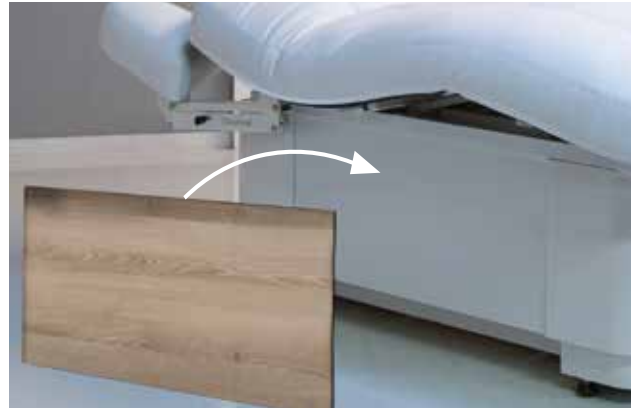

Exchangeable wood trim

Looking for a new design? Why not just swap out the entire table? The side trim on our MLW F1 Neo Wood can be very easily exchanged. Our numerous decors offer something for every ambience and a new, fresh look!



Specially formed front ends

The curved shape of the front ends made of aluminum provide you with enough legroom for all kinds of treatments. This way you can work in comfortably and enjoyably. The parts are available in different colors.



Spa Ambience Light

The concealed LED strip on the table base adds a light accent in your desired color to the MLW F1 Neo and ensures atmospheric lighting in your workspace.

Options (more info. after page 14)

	Soft Upholstery	---
	Electrical lowerable arm supports	---
	Thermo: Three-level heating system with automatic switch-off	---
	Vibro-Wellness: gently pulsating vibration system with many adjustment options	---
	Color upholstery PU: max. 2 colors possible, each color	---
	Multimedia sound system	---
	Metal parts in special colors (white, titanium, or dark brown are included in the table price)	---
	Decor surfaces our extended collection (standard collection: see page 17),	---
	Wired foot switch with memory function Bluetooth® foot switch with memory function	---
	Spa Ambience Light: Base with LED lighting	---

Accessories (see also page 146)

Dentalax neck rest, PU	---
Gel cushions for the face cradle	---
Terrycloth (white, black, macchiato, or choco)	---
Foot protective cover, PVC, transparent,	---
PU protective cover, Art. 49051	---



FORESTIS
Bressanone, Italy



MLW Neo series



Gharieni MLW Neo

Variable and individual: From the upholstery to the casing, many elements can be individually selected with this classic spa table. The low height of about 57 cm facilitates access and the maximum height of 92 cm allows back-friendly working. Table area widths in Small (76 cm), Medium (85 cm), and Large (92 cm) are available. In addition to the standard version, there is a soft PU upholstery available as well, offering exceptional comfort to meet every need – even during longer treatment sessions. Equipped with four actuators, the treatment positions can be set on this couch as well as two freely storable memory positions with the memory handset. The arm supports can be lowered by pneumatic springs.

Features:

- Table surface in three widths (S, M, and L)
- Height, back, leg, and foot section electrically adjustable
- Hand switch with locking and memory feature with four preset table positions
- Lowerable arm supports
- Head section +/- 30° tiltable
- Soft PU upholstery as standard and soft version
- Standard upholstery color: white or choco. Other colors from our color collection for an additional charge
- Base in five standard decors (see page 17), optional in other decors
- Mechanically retractable castors



- Height: 57-92 cm
- Length: 203 cm
- Width: S 76 cm / M 85 cm / L 92 cm
- Lifting capacity: 250 kg
- Load capacity of the table surface: 300 kg



MLW Neo with standard upholstery

MLW Neo

- | | |
|-----------------------|------|
| Small (width: 76 cm) | ,-,- |
| Medium (width: 85 cm) | ,-,- |
| Large (width: 92 cm) | ,-,- |



MLW Neo with soft upholstery

MLW Neo series



Gharieni MLW Amphibia Neo

Whether for classic facial and whole-body treatments "on land" or relaxing spa applications "on water," the MLW Amphibia combines both: The Aqua upholstery, as well as the firm padding, allow for a very flexible variety of treatments, even those currently in vogue.

The four actuators allow for a variety of height, back, thigh, and leg section adjustments. The access height is 54 cm. The head section can be tilted up and down by 30° each with a pneumatic spring and the arm supports are also continuously lowerable and therefore ideal for back treatments!

Features:

- Table surface with heated Aqua upholstery
- Height, inclination, as well as backrest and foot section electrically adjustable.
- Lowerable arm supports
- Head section +/- 30° tiltable
- Hand switch with locking and memory feature with four preset table positions
- Illuminated table surface and sides
- Soft PU upholstery can be exchanged for Aqua upholstery
- Inflation connection for optional Ayurveda cover
- Standard upholstery color: white or choco. Other colors from our color collection for an additional charge
- Base in five standard decors (see page 17), optional in other decors
- Mechanically retractable castors



- Height: 54-90 cm
- Length: 202 cm
- Base width: 55 cm
- Table surface width: 85 cm
- (Recommended) lifting capacity: 250 kg
- Load capacity: approx. 300 kg



MLW Amphibia Neo

Including water cushion



MLW Neo series



Perfect for any treatment

With four actuators, a height of 54-96 cm can be electrically adjusted on the MLW series table models. The backrest can also be adjusted electrically by approx. 70°, the leg area by approx. 25°, and the foot section by up to 18°. The arm supports can be

lowered by up to 15 cm using a pneumatic spring and the head section can be tilted by +/- 30°. The four pre-set treatment positions are also quite practical at work.





Comfortable soft upholstery

The extra-soft soft upholstery version of the MLW Classic will leave your customers floating on air. Made of skin-friendly, hygienic PU, the table upholstery is particularly suitable for long treatments.

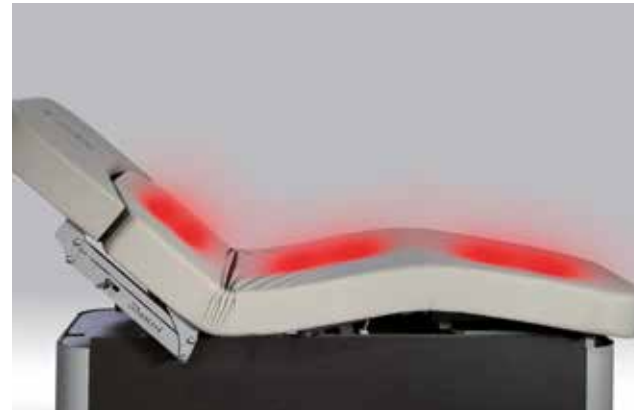

Optimally regulated warmth

The Thermo table heater has a temperature control with an automatic shut-off. This way you can ensure an optimal table upholstery temperature.

Options (more info. after page 14)

- ↕
 Soft Upholstery (not possible with MLW Amphibia) ---
- 🌡️
 Thermo: Three-level heating system with automatic switch-off (included with MLW Amphibia) ---
- Color upholstery:
 PU (white or choco included in price), each color ---
🖌️
 Only with MLW Soft:
 Synthetic leather standard, per color ---
 Synthetic leather Ferrari Stamskin Top, per color ---
 Synthetic leather Ferrari antibacterial coated, per color ---
- 🔧
 Metal parts in special colors (white, titanium, or dark brown are included in the table price) ---
- 📺
 Decor surfaces our extended collection (standard collection: see Seite 23), ---
- 👤
 Dual headrest (not with Amphibia) ---
- 👣
 Bluetooth® foot switch with memory function ---



Side shelves

On request, the table can be equipped with two shelves running along the side area. There's plenty of space for everything you need during your treatments.



Folding tray with magnetic closure

The practical folding tray at the head of the MLW allows e.g. a tablet with relaxing pictures or films to be placed there that make the view through the face cradle more comfortable for your customers.

Accessories (see also page 146)

- Dentalax neck rest, synthetic leather ---
- Dentalax neck rest, PU ---
- Gel cushions for the face cradle ---
- Terrycloth (white, black, macchiato, or choco) ---
- Foot protective cover, PVC, transparent, ---
- PU protective cover, Art. 49051 ---



C Mauritius Palmar, Mauritius

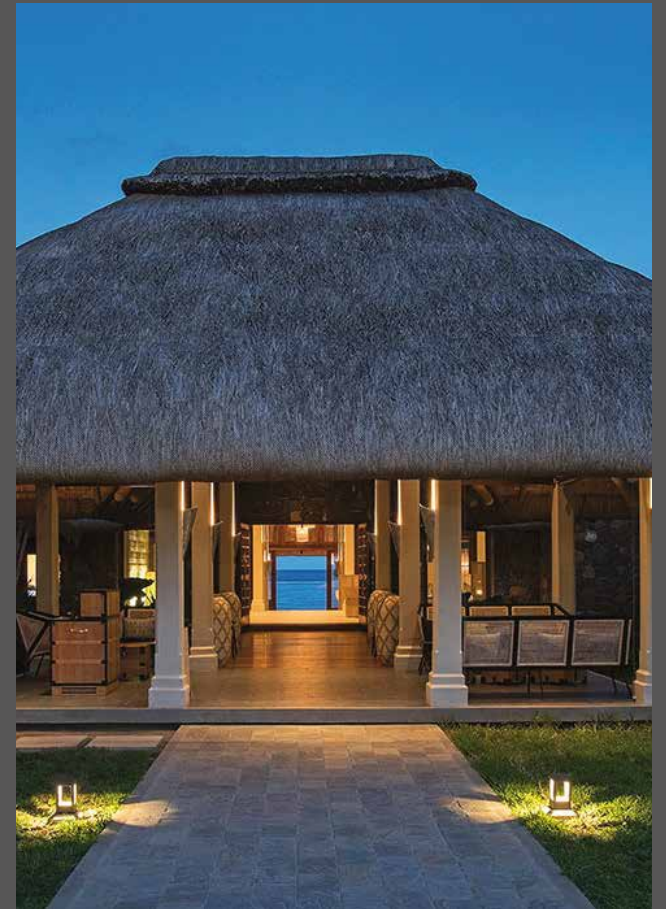



MLE Neo



Gharieni MLE Neo

The MLE Neo is an absolute all-rounder, because it is suitable for cosmetics, wellness, and massage alike. With three actuators, the height as well as the back and leg sections can be adjusted electrically. The head section can be inclined via a pneumatic spring by +/- 30°. To relieve the shoulder and neck area during massages, the arm supports can be lowered manually

Features:

- Height, back, and leg section adjustment via three actuators
- Head section +/- 30° tiltable
- Adjusting the head area via pneumatic spring
- Upholstery firmness: 10 cm
- Available in wenge with black-brown corners and choco-colored upholstery
- Including mechanically retractable castors



- Height: 58-92 cm
- Length: 204 cm
- Width: 84 cm
- Lifting capacity: 250 kg
- Load capacity of the table surface: 300 kg

Options (more info. after page 14)



Thermo: Three-level heating system with automatic switch-off

,-,-

Accessories (see also page 146)

Dentalax neck rest, PU

,-,-

Gel cushions for the face cradle

,-,-

Terry cloth cover

,-,-

Foot protective cover, PVC, transparent

,-,-

Foot protective cover, PVC, transparent,

,-,-

MLE Neo

3-actuator

,-,-

Spa Tables Accessories

Upholstery Covers

With the right covers your spa table will always be well protected against different types of stresses and strains. Our table-specific covers fit exactly the individual upholstery segments and thereby the function of the table is not limited.

Thanks to the high-quality terrycloth material, machine washing up to 60° C is possible and therefore hygienic cleaning is possible. Our covers are available in white, choco, macchiato and black.

It is best to order the right cover directly when you buy your table. Our team would be happy to help you decide!



Dentalax Neck Rest

This little tool can significantly improve the comfort of lying on your treatment table. Because the Dentalax supports the position of the neck and helps to stabilize the head. This creates a more comfortable table experience while relieving the neck vertebra. We recommend the Dentalax neck rest for each of our treatment tables as an optimal supplement for the best lying comfort and an increase in treatment ergonomics. The Dentalax is available to match the upholstery color of the table.

- Dentalax with PU, white
- Dentalax with PU, choco, creme, or cappuccino
- Dentalax with synthetic leather, white
- Dentalax with synthetic leather, in standard colors
- Dentalax with synthetic leather, in Stamskin colors



Foot protective cover

To protect the table areas at the foot end, we offer a suitable protective cover made of robust, transparent PVC for all tables. It can be securely fixed to the upholstery via Velcro.

Protective cover



Gel cushion for face cradles

Prevent unpleasant pressure points on the face with this gel cushion. In addition, the gel fluid has a pleasantly cooling effect. The transparent gel cushion can be securely attached to our tables by means of one or two tabs.

- Gel ring with 2 tabs
- Gel ring with 1 tab



Cover towel with face cradle, large

There is this special single-use cover towel with face cradle for improved hygiene. What makes it special: Thanks to its width, it not only protects the headrest, but also the arm supports against contamination. Ideal for all our tables with lowerable arm supports or wide head sections. Size: 130 x 35 cm

Package with 50 items, Art. 45310.



Face cradle towels

Extra soft, slotted disposable towel to protect the headrest upholstery; extremely practical and hygienic. Recommended for all headrests with face cradle. Size: 30 x 21 cm

Package with 100 items, Art. 45305



PU protective cover

With this practical cover made of robust PU material, nothing stands in the way of your special treatment any longer. Whether it's oil massages, packs, or the like, the upholstery is always well-protected. The cover has an elastic band to prevent unwanted slipping and can be washed at up to 90 °C. Available in white, choco, black, macchiato, or creme depending on spa table.

PU protective cover, Art. 49051



Ayurveda cover

The transparent Ayurveda cover is ideal for pouring oil. It features a drain which allows the oil to be cleanly drained away. The side edge is inflatable allowing the cover be stored to save space after use.

Ayurveda cover, Art. 49050



mikrozyd® sensitive

For the gentle and thorough care of our upholstery we recommend mikrozyd® sensitive. Available as liquid or ready-to-use cloths in a handy dispenser, it eliminates bacteria, fungi, and viruses (such as HBV, HIV, Rota, vaccinia). Without alcohol!

mikrozyd® sensitive Wipes, Art. 79418

mikrozyd® sensitive Liquid, Art. 79417



Spa tables accessories





PlexiShield

Gharieni's PlexiShield is the perfect solution to meet all strict hygiene requirements at work, especially during facial treatments. The thermoformed and ergonomic Gharieni PlexiShield can be easily attached to the metal frame under the headrest of all Gharieni spa tables of the MLW Neo, MLW F1 Neo and MO1 Neo series.

The direct connection to the frame ensures maximum legroom for the therapist when working on the headrest. Moreover, it eliminates the need for any additional height adjustment, as the shield automatically changes with the height of the spa table.

The depth (distance between the headrest and the shield) is also adjustable. When not in use, the shield can be easily removed and stored away, wasting no space in your treatment room. In this way, the entire shield, can be easily cleaned and disinfected. The Gharieni PlexiShield set includes the thermoformed shield, two rails and brackets for easy installation.

Art. W-SHIELD



PlexiShield with stand

- Height adjustable from approx. 115-145 cm
- Flat foot design for sliding under Gharieni treatment tables
- Easy running castors
- Perfect protection for flexible treatments

Art. 76119



Magnifying lamp with PlexiShield

- Lamp head with plexiglass screen
- 3 diopters
- Standpipe and flex hose made of robust metal
- 21 LEDs
- Dimmable
- Arm length approx. 83 cm

Art. 41999-SHIELD

Loungers



Gharieni
Evo Lounger



Gharieni
RLR



Gharieni
RL Aqua



Gharieni
RLX series



Evo Lounger

Gharieni Evo Lounger

This exclusive lounger offers pure relaxation. Equipped with four actuators, the head, back, leg, and foot sections can be adjusted separately via handheld remote control. The three most common table positions are preset and can be called up at the push of a button. Thanks to its special material, the upholstery is able to perfectly adapt to every body type. With a pull-out shelf on the left and right as well as an optional LED reading light, the Evo Lounger offers moments of well-being with maximum comfort. And that little extra: The lounger color can be individually designed. The standard white or choco PU upholstery is also optionally available in creme, black, and macchiato. The casing comes equipped standard in white or with wenge decor. This allows the lounger to integrate perfectly into any atmosphere, making it a truly personalized highlight for any relaxation area.

Features:

- Four actuators for adjusting the head, back, leg, and foot areas.
- Four pre-set positions
- Quilted PU upholstery
- Standard upholstery color: White. Other colors from our color collection for an additional charge
- Base in five standard decors (see page 17), optional in other decors
- Pull-out tray on both sides
- Optional LED reading light



- Lounger surface height: approx. 50 cm
- Length: 205 cm
- Width: 85 cm
- Load capacity of the table surface: 250 kg



Evo Lounger

4-actuator

,-,-

Evo Lounger

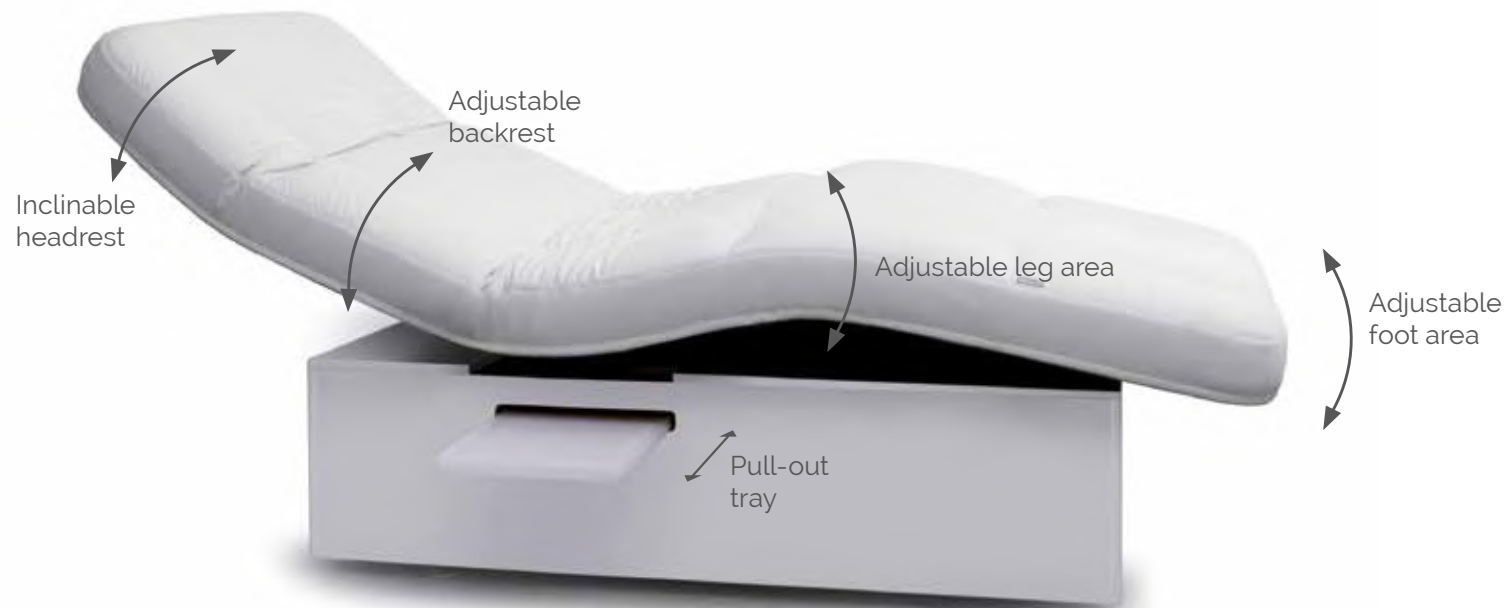

Relaxing lounger comfort

With four actuators and a handheld remote control, the Evo Lounger can be easily adjusted for optimal lying comfort. The head section can be raised by 35°, the back by 50°, the leg section by 20°, and the foot section by 18°. In addition, the upholstery

adapts to each customer individually and thus provides an additional relaxation factor. And the practical trays on both sides of the lounger can be easily pulled out with a handle.



Optional LED reading light

Equipped with a LED reading light, the lounge offers everything your customers need for a relaxing break (picture similar).



Pull-out tray

The pull-out tray on both sides is the perfect spot for setting something down or putting something away while reading with a wellness beverage.



Multimedia sound system





The integrated multimedia sound system allows you to load relaxing sounds and music on demand.



Easy to use

Three preset lounge positions can be accessed at the simple press of a button. Of course, the Evo Lounger is also individually adjustable.

Options (more info. after page 14)

-  Thermo: Three-level heating system with automatic switch-off ,-,-
-  Vibro-Wellness: gently pulsating vibration system with many adjustment options ,-,-
-  Color upholstery: PU (white or choco included in price), each color ,-,-
-  Multimedia sound system ,-,-
-  Decor surfaces: our extended collection (standard collection: see page 17), ,-,-

Accessories

- LED reading lamp ,-,-
- Dentalax neck rest, PU ,-,-
- Foot protective cover, PVC, transparent ,-,-

Eden One Dublin, Ireland





RLR & RL Aqua



RLR

In various colors

Gharieni RLR

Our extremely comfortable and practical recliner presents itself as if made of one piece. With its sophisticated, elegant design and many color options, it fits into almost any ambience. The soft upholstery impresses with its excellent reclining properties as well as a durable, water-repellent cover with a pleasant feel. The ergonomic shape makes the Gharieni RLR a first-class lounge for exclusive, spas, hotels and many other areas.

Features:

- Modern design
- Robust manufacturing
- Pleasantly soft upholstery
- Easy-care, water-repellent cover
- Optional imitation leather, waterproof coated
- Available in different colors



Choose your favorite color from the RLR color palette or our standard upholstery colors (page 25)!

Options (more info. after page 14)



Synthetic leather standard, waterproof coated
Synthetic leather Ferrari Stamskin Top, waterproof coated



- Height: 86 cm
- Length: 173 cm
- Width: 64 cm
- Load capacity of the table surface: 350 kg



Gharieni RL Aqua

This lounger offers pure relaxation "with water." For the best possible comfort, the heated waterbed also has an intermediate layer of foam. The robust and easy-to-clean synthetic leather surface is available in various colors. The RL Aqua is available in different dimensions for an additional charge.

Features:

- Heated water bed
- Soft intermediate layer of foam
- Easy-to-clean synthetic leather surface
- Standard upholstery color: White. Other colors from our color collection for an additional charge
- Base in five standard decors (see page 17), optional in other decors
- Optionally in various lengths and widths

RL Aqua
Including heating

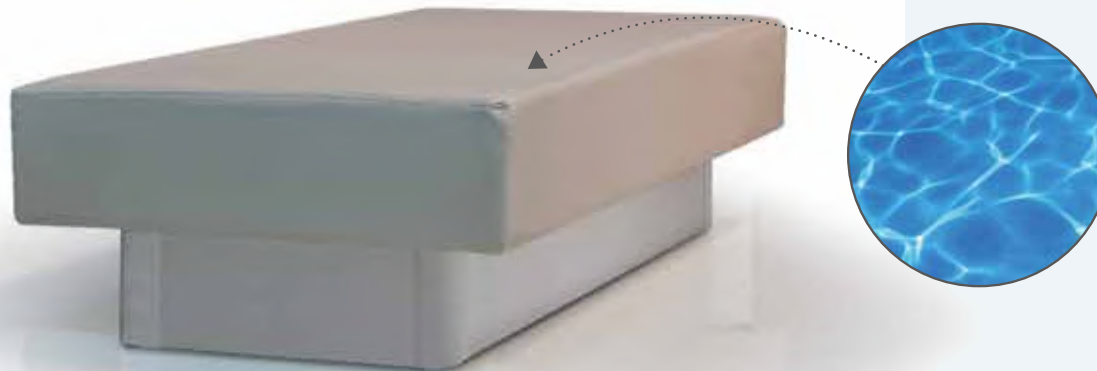

Options (more info. after page 14)



- Color upholstery:
- Synthetic leather standard, per color
 - Synthetic leather Ferrari Stamskin Top, per color
 - Synthetic leather Ferrari antibacterial coated, per color



- Height: 49 cm
- Length: 202 cm
- Width: 91 cm
- Load capacity of the table surface: 160 kg



Swinton Park
Ripon, UK



RLX series



RLX Light

Gharieni RLX Series

The RLX, with its soft and easy-to-clean synthetic leather upholstery is specially designed for the rest area of a spa. With its exceptional design and different equipment options, the lounge fulfills all desires. For example, the motorized tilt adjustment makes the RLX Electric a truly unique lounge. This lounge can also come with heating upon request. With optional reading light and removable neck cushion, the RLX models are the perfect solution for pleasant relaxation.

Features:

- Lounge in two versions
- Extraordinary design
- Choose from numerous design variants
- Easy-to-clean synthetic leather cover
- Standard upholstery color: White. Other colors from our color collection for an additional charge
- RLX Electric with electrical inclination adjustment
- Fixed lounge surface position on RLX Light
- Heating optional for RLX Electric lounge surface
- Optional color-matched neck rest
- Optional LED reading light



RLX Electric



RLX Light

RLX Electric

- Access height: 45 cm
- Projection length: 190 cm
- Width: 70 cm
- Load capacity of the table surface: 160 kg

RLX Light

- Access height: 38 cm
- Projection length: 174 cm
- Width: 66 cm
- Load capacity of the table surface: 160 kg

RLX Electric

1-actuator	---
------------	-----

RLX Light

Without actuators	---
-------------------	-----

RLX series



The models to choose from

With their high-end design and high degree of quality, the RLX models truly stand out. While the position of the lounge surface is fixed with the RLX Light, on the RLX Electric the lounge surface can be electrically adjusted. You're not just choosing "your" model, but also the best upholstery color and coating of

the metal parts for your atmosphere – for your relaxation area's perfect look. With optional extras such as the Thermo heating system for a comfortable temperature of the lounge surface, downtime on the RLX for your customers becomes a real relaxation experience!

Options (more info. after page 14)

- 🌡️
Thermo: Three-level heating system with automatic switch-off (only available for RLX Electric)
,--
- 🖌️
Color upholstery:
Synthetic leather standard, per color
Synthetic leather Ferrari Stamskin Top, per color
Synthetic leather Ferrari antibacterial coated, per color
,--
,--
,--
- 🔩
Metal parts in special colors (white, titanium, or dark brown are included in the table price)
,--



LED reading lamp

The optionally available LED light for reading makes relaxation time on the RLX even more enjoyable for your customers. Its flexible neck makes it easy to put it in the right position..



Removable neck cushion

The neck cushion, which can be easily removed if necessary, offers perfect lying comfort. It can be optimally positioned via a Velcro fastener.



Optimally regulated heat

The RLX Electric can be equipped with a heatable lying surface. This Thermo system has a temperature control including automatic switch-off. This ensures an optimally tempered lying surface. .



Especially stable

An elegant appearance combined with maximum stability – this is ensured by the sophisticated metal construction of the RLX. This can optionally be coated in your personally favorite color.

Accessories

- Neck cushion, white
,--
- Neck cushion, in colors
,--
- LED reading lamp
,--

Zoya Health & Wellbeing Resort Ajman, UAE



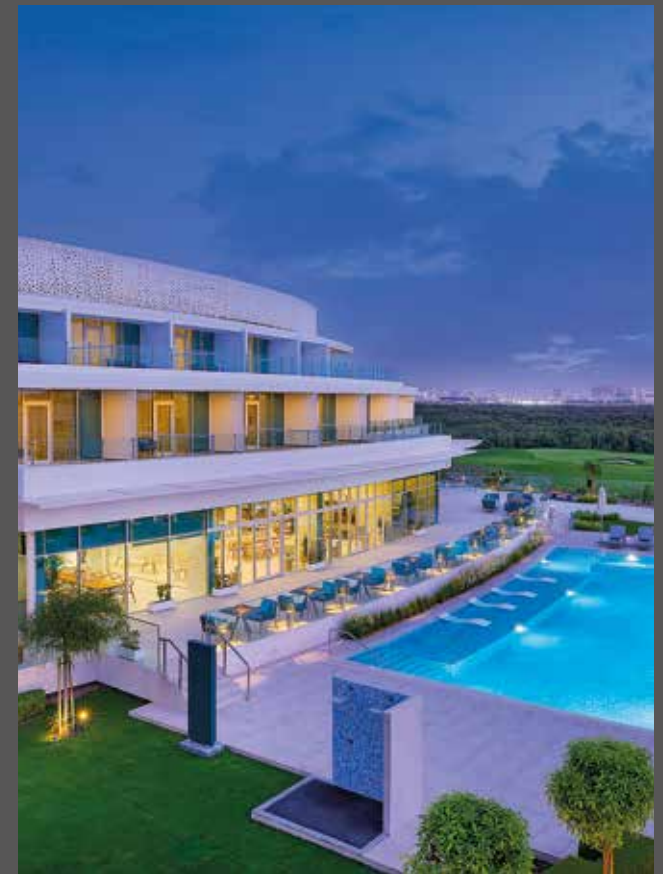

Massage Tables



Gharieni
MLW Transform



Gharieni
ML series



Gharieni
Ayurveda



Gharieni
Shiatsu mat

MLW Transform



Gharieni MLW Transform

The MLW Transform gives the term "feel-good sofa" a whole new dimension, because this high-end couch transforms into a massage table in no time.

The massage table, with its independent battery and pull-out cable is of course height-adjustable and can be heated for a cozy, feel-good experience. For optimum comfort, the head section can also be adjusted for height and inclination.

If you need more seat space, the three cushions on the backrest of the couch can simply be removed. The high-quality, elegant synthetic leather cover of the upholstery is available in various decors and colors. For a very personalized look, the sofa can also be equipped with a leather cover or a (customer's) cover fabric on request.

Features:

- Massage table and sofa in one
- Pull-out massage table
- Height electrically adjustable
- Electrically extending lightweight castors
- With integrated battery and power connection
- Removable, crescent-shaped head section
- Storage compartment in the base
- Robust synthetic leather upholstery in black
- Optional in various decors, leather, or (customer's) cover material
- Three removable cushions on the backrest



- Couch height: approx. 80 cm
- Table height: approx. 45–75 cm
- Couch width: approx. 212 cm
- Spa Table:
- Length without head section: approx. 166 cm
- Couch depth: approx. 87 cm
- Spa Table: Width approx. 75 cm
- (Recommended) lifting capacity: 250 kg
- Load capacity of the table surface: 300 kg

MLW Transform

Sofa-massage table combination	,-
Individual massage table	,-
Sofa as purely seating furniture	,-



MLW Transform

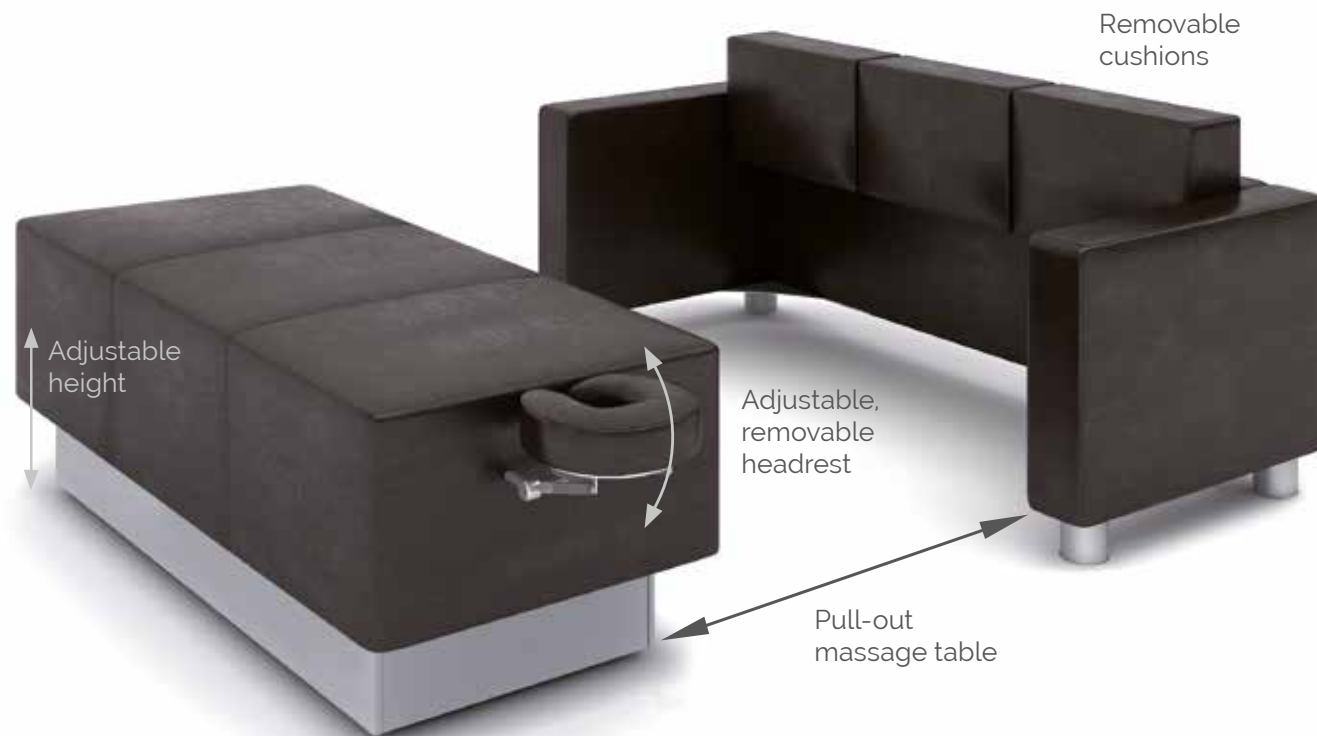

Two-in-one

The high-end "feel-good sofa" can easily transform into a massage table: Pull out with the electrically retractable lightweight castors and attach the adjustable crescent-shaped head section – done! For massage treatments, the height can be adjusted

electrically from 45-75 cm. In addition to a cord connection, the MLW Transform also has a battery and can thus be used away from a wall power outlet.

Options (more info. after page 14)

- 🔧
 Color upholstery:
 - Synthetic leather standard, per color ,-,-
 - Synthetic leather Ferrari Stamskin Top, per color ,-,-
 - Synthetic leather Ferrari antibacterial coated, per color ,-,-
- 📦
 Decor surfaces our extended collection (standard collection: see page 17), ,-,-



Flexible headrest

The crescent-shaped, adjustable headrest is easy to put on – the massage table is ready!



Practical storage compartment

With a practical storage compartment in the base of the massage unit, the headrest is always ready at hand.



Battery operation

With its integrated battery, the MLW Transform can be used independently of a wall power outlet. It is charged via the pull-out power cord.

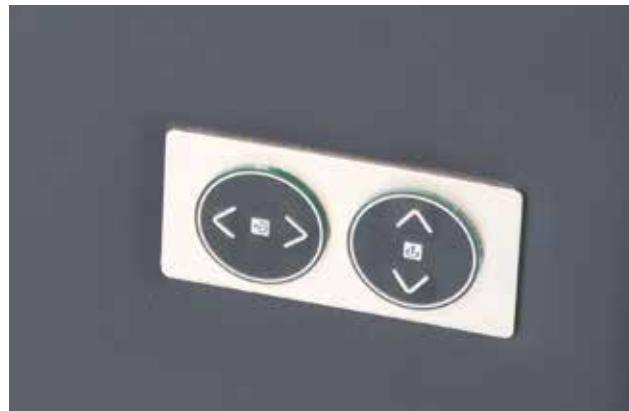

Easy to use

Thanks to the integrated touch panel, the electrically extendable lightweight castors can be easily activated and the height of the table surface can be adjusted.

ML series



Gharieni ML series

All tables in the ML series are electrically height-adjustable. The head section can be inclined pneumatically via pneumatic spring by +/-30°. In the two-actuator version, the head area of the MLK can be adjusted electrically as well as on the MLL. The MLK ABS and MLK Physio are equipped with arm supports that can lower you for prone treatments, while the MLL offers a larger head section. The base is available in both white (standard) and titanium (optional).

Features:

MLK ABS

- Electrical height adjustment
- Lowerable arm supports
- Head section with face cradle inclinable +/-30°
- White synthetic leather upholstery, optional in other colors

MLK Physio

- Electrical height adjustment
- electrical adjustment of the elevated center position
- Lowerable arm supports
- Head section with segmented face cradle inclinable +/-30°
- White synthetic leather upholstery, optional in other colors

MLK

- Electrical height adjustment
- Head section with face cradle inclinable +/-30° via pneumatic spring (optional electric)
- White synthetic leather upholstery, optional in other colors
- Short head section with face cradle

MLL

- Electrical height adjustment
- Head section inclinable +/-30° via pneumatic spring (optional electric)
- White synthetic leather upholstery, optional in other colors
- Long head section with face cradle



- Height: 61-91 cm
- Length: 196 cm
- MLK (ABS) head section length: 42 cm
- MLL head section length: 67 cm
- Width: 70 cm
- (Recommended) lifting capacity: 200 kg
- Load capacity of the table surface: 250 kg



MLK ABS

1-actuator (height)

,-,-



MLK Physio

2-actuator (height, elevated center)

,-,-



MLL

1-actuator (height)

,-,-

2-actuator (height, head section)

,-,-



MLK

1-actuator (height)

,-,-

2-actuator (height, head section)

,-,-

ML series



The massage specialists

The "MLK ABS," "MLK Physio," "MLK," and "MLL" massage tables are electrically height-adjustable from 61-91 cm and their head section can be tilted via pneumatic spring; on the MLL and MLK this is +/- 30° also possible electrically on the two-actuator

version. The MLK ABS and MLK Physio are also equipped with lowerable arm supports, with the MLK Physio also having a segmented table surface for setting an elevated center position.

Options (more info. after page 14)

- 🌡️
Thermo: Three-level heating system with automatic switch-off

- 🖌️
Color upholstery:
Synthetic leather standard, per color

- 🖌️
Synthetic leather Ferrari Stamskin Top, per color

- 🖌️
Synthetic leather Ferrari antibacterial coated, per color

- ✍️
Logo embroidery: depending on effort,

- 🔧
Base casing in titanium color

- 🎯
Castor set, brakable, Art. 73006

- 👣
Foot switch to control the basic functions
on the single-actuator version
on the two-actuator version



For prone treatments

The MLK ABS and MLK Physio models are equipped with lowerable arm supports and a downwards and upwards tilting headrest with face cradle. This makes them suitable for all prone treatments.



Special elevated center position

To provide relief for your customer's lumbar spine area, the table surface can be brought into an elevated center position by the actuator on the MLK Physio.



Paper roll holder

With a paper roll holder mounted at the foot of the table, you can always pull protective paper over the table (see also page 188).



Everything within reach

The compartment under the MLK and MLK ABS serves as a handy storage space, e.g. for hand towels. If necessary, the compartment can be supplemented with a second shelf.

Accessories (see also page 188)

- Roll holder 1 paper roll, 60 cm width, Art. 42068/60

- Roll holder 1 paper roll, 70 cm width, Art. 42068/70

- Dentalax neck rest, synthetic leather

- Gel cushions for the face cradle

- Terrycloth (white, black, macchiato, or choco)

ZillergrundRock Luxury Mountain Resort Mayrhofen, Austria





Photos: © ZillertalRock Luxury Mountain Resort

Ayurveda Table

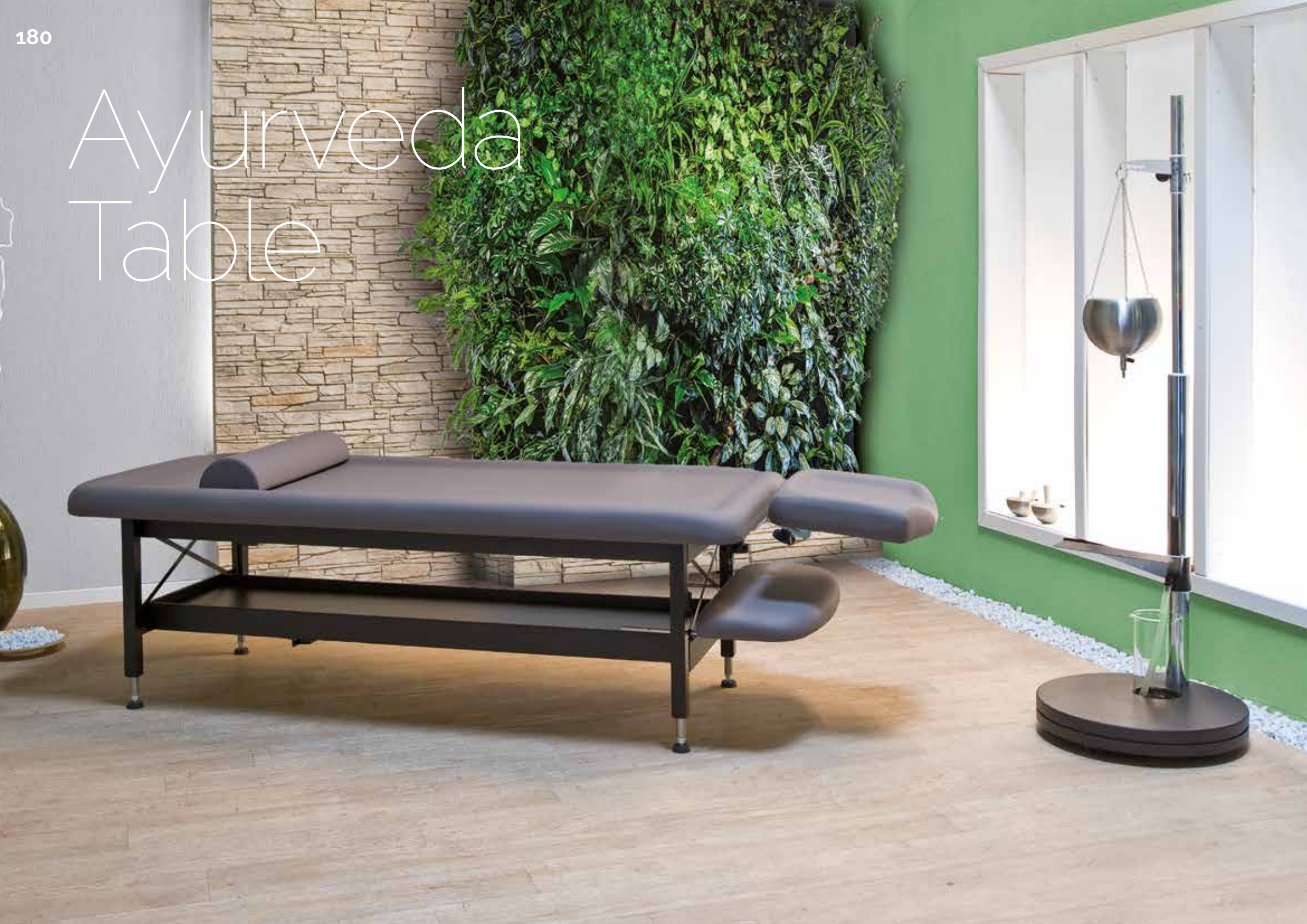

Gharieni Ayurveda Table

Thanks to its special design, this table is suitable for all Ayurvedic treatments. The upholstery features a raised edge for use with larger quantities of oil and an oil-resistant PU cover. The accompanying four-piece PU accessory set consists of an Ayurveda half roll, a crescent-shaped massage headrest, an arm support, and a headrest with drainage device.

The table height can be manually adjusted hydraulically or electro-hydraulically. The large shelf below the bed can be used for everything you need for treatment.

Features:

- Upholstery especially for Ayurvedic treatment methods
- Elevated upholstery edge for use of larger amounts of oil
- Oil-resistant PU cover
- With hydraulic, electro-hydraulic or without height adjustment
- Four-piece PU accessory set with Ayurveda half roll, special headrest with drain, crescent-shaped massage headrest, and arm support

Ayurveda Table

Electrohydraulic, Art 49043	---
Hydraulic, Art 49042	---
w/o height adjustment, Art 49040	---



- Height (without edge): 58-88 cm
- Length: 200 cm
- Width: 85 cm
- Lifting capacity: 200 kg
- Load capacity of the table surface: 200 kg

Ayurveda Table



The oil can flow here

The height of the Ayurveda table can be adjusted hydraulically by hand crank or electro-hydraulically by pressing a button from 58-88 cm. The headrest can be tilted up and down and

the arm support can be attached at different heights. For the use of larger quantities of oil, the seat cushion is equipped with a raised edge and an oil-resistant PU cover.

Options (more info. after page 14)



Thermo: Three-level heating system with automatic switch-off

,-,-

Accessories (see also page 188)

Oil-resistant protective cover, washable, choco, Art. 49051

,-,-

Face cradle towels, 100 pieces, Art. 45305

,-,-

Washable fleece, 10 pieces, Art. 45302

,-,-



Perfect for oil treatments

The head section is designed so that the oil can run off cleanly during forehead pouring.



Headrest for massages

With the crescent-shaped, tiltable, and removable headrest with face cradle, massage treatments can also be performed prone.



Pull-out arm support

The arm support can be mounted at two different heights or completely removed. There is enough space there if the customer is lying prone.



Practical storage shelf

On the surface below the table, you can store or set aside everything important for your treatments.

HUBERTUS Mountain Refugio Allgäu

Balderschwang, Germany





Shiatsu mat

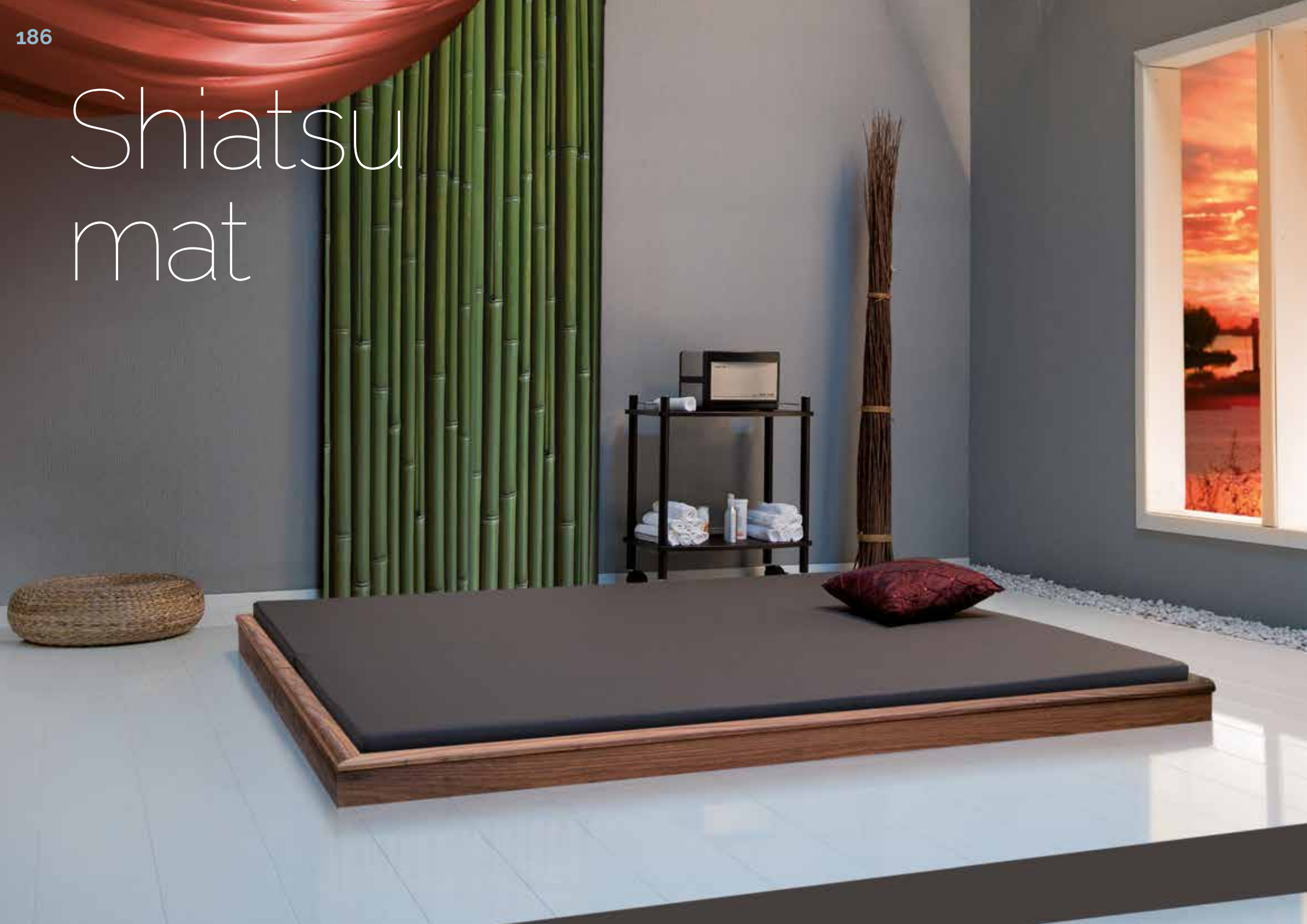



Gharieni Shiatsu mat

Do you prefer relaxing shiatsu massages, a form of energetic body work developed in Japan? Then we have a practical solution for you: A Shiatsu mat with skin-friendly and hygienic PU cover in the color Choco. The mat with firm foam filling is collapsible and the optional real wood frame is easy to share. In addition, the high-end frame is available in different colors. On request, it can also be equipped with an LED light bar. This way you can create a very special, atmospheric ambience!

Features:

- Collapsible
- Firm foam filling
- PU cover optional in five different colors
- Optional high-end real wood frame in different colors
- LED light bar optional

Options (more info. after page 14)

-  Color upholstery PU:
max. 2 colors possible, each color ,-,-
-  Other frame woods and coatings ,-,-
-  LED lighting in the frame ,-,-



- Mat thickness: 8 cm
- Width: 180/90 cm
- Depth: 200 cm

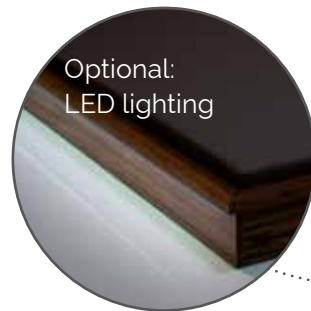

Optional:
LED lighting



Shiatsu mat	
Without frame	,-,-
With frame	,-,-

Massage Tables Accessories

Upholstery Covers

With the specially adapted covers your massage table is always well protected against different types of stress. The table-specific covers are an exact match to the individual upholstery segments.

Thanks to the high-quality terrycloth material, machine washing up to 60° C is possible and therefore hygienic cleaning is possible. With their integrated elastic bands, the individual segments stay exactly where they belong, thus preserving the function of the tables.

Our covers are available in white, choco, macchiato and black. It is best to order the right cover directly when you buy your table. Our team would be happy to help you decide!

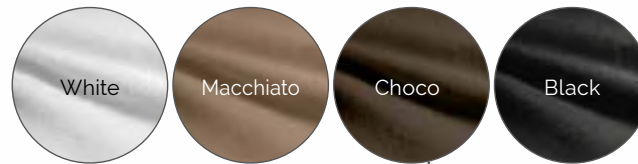

Roll holder including 1 paper roll

The optional paper roller provides you with a practical, disposable protection for your table. As needed, the 50 cm wide paper is unrolled and pulled over the lying surface. After use simply tear it off at the perforation line and discard. A neat thing!

Roll holder 1 paper roll, 60 cm width, Art. 42068/60 -,-

Roll holder 1 paper roll, 70 cm width, Art. 42068/70 -,-

Sanitary paper roll, 50 x 0,5 m, Art. 42065, up to 8 pieces, ea. -,-

Sanitary paper roll, 50 x 0,5 m, Art. 42065, 9 pieces, ea. -,-



Face cradle towels

Extra soft, slotted fleece disposable towel to protect the headrest; extremely practical and hygienic. Recommended for all headrests with face cradle. Size: 30 x 21 cm

Package with 100 items, Art. 45305 ---



Practical disposable towel specially for u-shaped headrests. Thanks to the one-sided opening in the towel, it can be perfectly adapted to the massage head rest.

Package with 100 items, Art. 45301 ---



Cover towel with face cradle, large

There is this special single-use cover towel with face cradle for improved hygiene. The special thing about it: its width not only protects the headrest but also the arm supports against contamination. Ideal for all our tables with lowerable arm supports or wide head sections. Size: 130 x 35 cm

Package with 50 items, Art. 45310 ---



mikrozyd® sensitive

For the gentle and thorough care of our upholstery we recommend mikrozyd® sensitive. Available as liquid or ready-to-use cloths in a handy dispenser, it eliminates bacteria, fungi, and viruses (such as HBV, HIV, Rota, vaccinia). Without alcohol!

mikrozyd® sensitive wipes, Art. 79418 ---

mikrozyd® sensitive liquid, Art. 79417 ---

Washable fleece

Practical and comfortable cotton wool table cover. The material is washable up to 10 times. 80 x 200 cm

Package with 10 pieces, Art. 45302 ---



Treatment Beds

Our treatment beds are functional and flexible. The seats are versatile and adjustable and can be controlled by hand switch. Depending on the bed model, up to eight positions can be saved via memory function. The quality actuators from Linak have the "Spline" safety feature, which prevents the danger of crushing on moving parts. For non-actuator-driven table parts, Stabilus pneumatic springs provide easy adjustment without much effort.

The construction of the tables was designed taking ergonomic aspects into account. Numerous elaborate details, such as the optional Rotonde turning function, make the job easier. Pull-out head and foot sections provide comfort to customers of all body types.

A particular highlight is the Airback®, a lumbar support system whose adjustment is controlled by air pressure via a hand pump.

Airback® comes standard in all treatment beds.

The treatment beds always come equipped with a white Gharieni synthetic leather upholstery or white or choco PU. Here you can choose from a large number of colors in addition to the

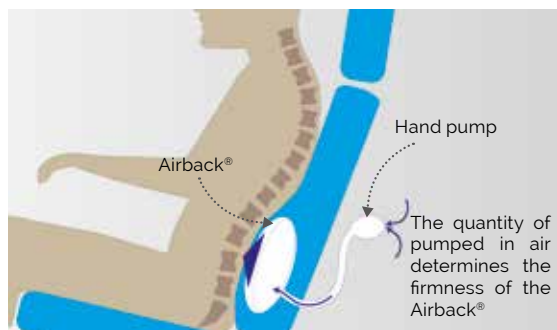

standard equipment. These can be found in the rear flap of the catalog. Choose your favorite from the Gharieni color chart or from the exclusive Ferrari Stamskin top collection! On some bed models, you can put together your own personalized bed from up to three different colors. The casing is made from robust, easy-to-clean, and colorfast plastic. It is available on almost all models in addition to the standard white in titanium.

The options table will show you which equipment options you have that can be found on the corresponding beds. The individual options are then Seite 16 explained from there. You can find an extensive list of accessories at the end of each bed section.



Gharieni
Lina Select series



Gharieni
601 series



Gharieni
SPL Neo series



Gharieni
SLR



Gharieni
Hydraulic series

Lina Select series



Lina Select series

Slim, elegant design, maximum comfort and variability. – Our Lina Select series is the ultimate for you as a beautician! Because the innovative Lina's program is "Select," which combines optimal working and table comfort as well as individual versatility.

You can thus choose from the following versions of the one-piece upholstery cover with memory foam:

- Standard – the perfect "bottom layer" for massages
- Soft – for even more comfort, even with time-consuming cosmetic treatments

Particularly practical: On all models, the armrests for massage treatments feature double-sided upholstery and can be folded down. In addition, the head and foot sections can be pulled out and removed. And of course you can adjust the height, inclination, back, and leg sections electrically and store up to four positions. In addition, the bed can be equipped with the upholstery-warming heating system. All Lina Select models are also available as Podo version with segmented foot section.

Gharieni Lina Select Alu

The Lina Select Alu features a sophisticated designer aluminum base with upholstery or wood applications.

Features:

- Metal-clad base in the colors titanium, white, black-brown or aluminum
- With side wood or synthetic leather applications
- Pull-out and removable head and foot sections
- Electrical height, back, and seat adjustment
- Hand switch with locking and memory feature with four preset table positions
- Fold-back armrests upholstered on both sides
- Upholstery with a memory foam layer
- Upholstery sewn into one piece
- "Airback" lordosis support system integrated into the upholstery (see page 190)



- Height: 54-96 cm
- Bed surface length: max. 202 cm
- Width without/with armrests: 62/80 cm
- Lifting capacity: 200 kg
- Load capacity of the seat: 250 kg



Lina Select Alu
with standard upholstery

Lina Select Alu

4-actuator,



Lina Select Alu
with Soft upholstery

Gharieni Lina Select Wood

Equipped with the same features as the other Lina Select models, the Lina Select Wood has a delicate, yet stable base. The foot is available in one of our numerous wood decors. This allows the bed to be perfectly adapted to your interior design – giving your workspace a particular bit of elegance.

Features:

- Delicate base in five standard decors (see page 17)
- Additional decors optionally available
- Pull-out and removable head and foot sections
- Height, back, seat inclination, and leg section electrically adjustable via hand switch
- Upholstery sewn into one piece
- Standard upholstery color: White and choco. Other colors from our color collection for an additional charge
- With a memory foam layer
- Fold-back armrests upholstered on both sides
- "Airback" lordosis support system integrated into the upholstery (see page 190)
- Hand switch with locking and memory feature with four preset table positions



Lina Select Wood
with standard upholstery

Lina Select Wood

4-actuator



- Height: 54-96 cm
- Bed surface length: max. 202 cm
- Width without/with armrests: 62/80 cm
- Lifting capacity: 200 kg
- Load capacity of the seat: 250 kg



Lina Select Wood
with Soft upholstery

Gharieni Lina Select Static

With its one-pillar technology and solid floor installation, the Lina Select Static looks particularly elegant. At the same time it gives you practical legroom with maximum stability. In addition, this model has the same features as the "Wood" and "Alu."

Features:

- Bolted to the floor for maximum stability and legroom
- Four-actuator
- Height, back, seat inclination, and leg section electrically adjustable via hand switch
- Pull-out and removable head and foot sections
- Upholstery sewn into one piece
- Standard upholstery color: White and choco. Other colors from our color collection for an additional charge
- With a memory foam layer
- Fold-back armrests upholstered on both sides
- "Airback" lordosis support system integrated into the upholstery (see page 190)
- Hand switch with locking and memory feature with four preset table positions



Lina Select Static
with standard upholstery

Lina Select Static

4-actuator



Lina Select Static
with Soft upholstery



- Height: 54-96 cm
- Bed surface length: max. 202 cm
- Width without/with armrests: 62/80 cm
- Lifting capacity: 200 kg
- Load capacity of the seat: 250 kg

Lina Select series













Extraordinarily variable

All of the Lina Select series models are extraordinarily versatile. The height is adjustable from 54-96 cm and the head and foot sections can each be pulled out by 10 cm. The backrest can be

set up to 70° and the seat can be tilted by 25°. In addition, the leg area can be tilted down by 75°. And for massage treatments, the double-upholstered arm supports can be folded down.



Options (more info. after page 14)

-  Soft Upholstery ,-,-
-  Thermo: Three-level heating system with automatic switch-off ,-,-
-  Vibro-Wellness: gently pulsating vibration system with many adjustment options ,-,-
-  Color upholstery:
 PU (white or choco included in price), each color ,-,-
 Synthetic leather standard, per color ,-,-
 Synthetic leather Ferrari Stamskin Top, per color ,-,-
 Synthetic leather Ferrari antibacterial coated, per color ,-,-
-  Logo embroidery: depending on effort, ,-,-
-  XL Extension Attachment to expand the bed in the upper back area ,-,-
-  Color XL Extension: max. 2 diff. colors
 Synthetic leather standard, per color ,-,-
 Synthetic leather Ferrari Stamskin Top, per color ,-,-
-  Metal parts in special colors (white, titanium, or dark brown are included in the table price) ,-,-
-  Decor surfaces our extended collection (standard collection: see page 17), ,-,-
-  Castor set, brakable, Art. 73006 ,-,-
-  Wired foot switch with memory function
 Bluetooth® foot switch with memory function ,-,-

Accessories (see also page 218)

- Dentalax neck rest, synthetic leather ,-,-
- Dentalax neck rest, PU ,-,-
- Terrycloth (white, black, macchiato, or choco) ,-,-
- Foot protective cover, PVC, transparent ,-,-



High-end application

The sides surfaces of the foot of the Lina Select Alu feature the same synthetic leather as the bed upholstery. Optionally, however, it is also possible to choose an elegant wood decor.



Usable on both sides

Particularly practical: On all Lina Select models, the armrests feature double-sided upholstery and can be folded down. This allows them to be used for prone massage treatments.



Lightweight, elegant, & stable

The foot of the Lina Select Wood looks elegant, but at the same time it is extremely stable. With a wood decor of your choice, the bed can be perfectly adapted to the ambience of your workspace.



Headrest with face cradle

In addition to the standard headrest, an optional headrest with an integrated face cradle is also available for our Lina Select models.

Hotel Edelweiss Berchtesgaden

Berchtesgaden, Germany





601 series



Gharieni 601

The Gharieni 601 combines the best features of a spa table and treatment bed in one: comfort, stability and practical handling are the main features of this double lifting column supported combination table. Whether cosmetic treatments, make-up, haircare, massages, pedicures or manicures, the 601 always performs well. The multifunctional, removable head and arm rests make it one of our most variable treatment tables.

Features:

- Double lifting column technology for extreme loads
- Fully electrically adjustable
- Upholstery of the treatment bed available in three widths: 75 cm (small), 80 cm (medium-small) and 85 cm (medium)
- Upholstery available in two thicknesses: standard and soft
- Three different headrests possible:
 1. Dual headrest with interchangeable face cradles
 2. U-shaped face cradle
 3. Standard headrest with face cradle
- Fold-away head rest for free access to the head and neck (e.g. for hair wash)
- Thermal heatable surface to keep clients cozy and comfortable.
- Swiveling, detachable side armrests for easy access
- Laterally swiveling and lowerable arm support at the head section for effective massages
- Can be operated via hand or foot switch
- Four preset and two freely storable memory positions
- 30 minutes automatic operation safety lock
- Mounting for magnifying lamps
- Mountings for manicure bowls under the lateral armrests
- Available in many different finishes and fully customizable to any décor.
- Also available as High Performance version with approx. 60% more lifting force and 25% higher speed



- Height: approx. 59 cm - 99 cm (Standard upholstery)
- Length: approx. 183 cm - 203 cm
- Width (without armrests): 75/80/85 cm
- Lifting capacity: 250 kg/400 kg (High Performance)
- Load capacity of the table surface: 300 kg / 450 kg (High Performance)



601 with standard upholstery



601 High Performance with soft upholstery

601

(without armrests/arm supports/headrest)

Small (width: 75 cm)	,-,-
Medium-Small (width: 80 cm)	,-,-
Medium (width: 85 cm)	,-,-

601 High Performance

(without armrests/arm supports/headrest)

Small (width: 75 cm)	,-,-
Medium-Small (width: 80 cm)	,-,-
Medium (width: 85 cm)	,-,-

Standard headrest	,-,-
U-shaped face cradle	,-,-
Dual headrest	,-,-
Lateral armrests (pair)	,-,-
Arm supports at head section (pair)	,-,-



601 High Performance
• with lateral armrests
• dual headrest

601 High Performance
• with lateral armrests
• without headrest

601 High Performance
• with arm supports
• without lateral armrests
• with standard headrest

601



Practical & versatile

In terms of adjustability, versatility and ergonomics, the 601 meets the highest demands. The headrest can be tilted by $-90/+10^\circ$ and extended by up to 15 cm. Two lifting columns allow the height to be electrically adjusted from 59-99 cm, the back and foot sections

can be adjusted by 70° and 91° respectively, and the armrests can be swiveled back by 180° . The lying surface can be tilted by $\pm 25^\circ$ and extended by approx. 10 cm with the adjustable foot section.





Three different headrests









In addition to the standard headrest, the 601 can be equipped with two other variants: the Dual, with an exchangeable round or crescent-shaped face cradle or U-shaped headrest



Adjustable armrests

For optimal adaptation to the customer, the armrests can be moved outwards. Thus, the 601 offers even more comfort for every body type..

Options (more info. after page 14)

-  Soft Upholstery ---
-  Thermo: three-stage heating system with automatic switch-off ---
-  Vibro-Wellness: gently pulsating vibration system with many adjustment options ---
- Color upholstery:
 - PU (white or choco included in price), each color ---
 - Synthetic leather standard, per color ---
 - Synthetic leather Ferrari Stamskin Top, per color ---
 - Synthetic leather Ferrari antibacterial coated, per color ---
-  Metal parts in special colors (white, titanium, or dark brown are included in the table price) ---
-  Decor surfaces our extended collection (standard collection: see page 17), ---
-  Dual headrest ---
-  Wired foot switch with memory function (only for "High-Performance" models) ---
-  Bluetooth® foot switch with memory function ---
-  Castor set, brakable, Art. 73006 ---

Accessories

- Dentalax neck rest, synthetic leather ---
- Dentalax neck rest, PU ---
- Roll holder 1 paper roll ---
- Gel cushions for the face cradle ---
- Terrycloth (white, black, macchiato, or choco) ---
- Foot protective cover, PVC, transparent ---
- Double-sided (magnifying) lamp mount ---
- LED Magnifying Lamp "Circle" ---
- Manicure bowl holder (both sides) ---



Paper roll holder

With a paper roll holder mounted on the back of the couch, you can always pull protective paper over the treatment bed.



Holder for (magnifying) lamps

A surprising and handy feature is the extendable magnifying lamp holder made of stainless steel. Designed to fit the Circle LED magnifying lamp, it simply disappears under the bed when not in use.



Wellness Hotel Kessler-Meyer
Cochem, Germany



SPL Neo series



Gharieni SPL Neo series

If you are looking for a solid treatment bed, our "SPL Neo" is just right for you. With its four actuators, the bed can be adjusted as quickly as you want: From starting position to the classic treatment position, to the massage position, you can retrieve them simply by pressing a button.

With the "Standard", "XP" and "Soft" upholstery versions, the three beds offer different characteristics especially for your treatments. Fold-down armrests as well as a lower bed access height make it easier for shorter customers to step up. At the same time, the pull-out headrest and footrest offer taller people optimal comfort. The seat surface rotates thanks to the optional Rotonde function. This gives you even more flexibility when working. You can choose the color of the bed upholstery – for the best look to match the ambience of your workspace – from our large PU and synthetic leather collection.

The SPL Neo is also available as a Podo version.

Features:

- Four particularly quick actuators
- Height, inclination, as well as back and leg areas are electrically adjustable.
- Fold-down armrests
- Pull-out headrest and footrest
- "Airback" lordosis support system integrated into the upholstery (see page 190)
- Spline safety actuators to avoid the danger of crushing
- Optional Rotonde seat surface rotating function
- Bed surface available with Standard and Soft upholstery
- Upholstery made from PU (Soft version) or synthetic leather
- Standard upholstery color:
Synthetic leather: White. PU: White and Choco
Other colors from our color collection for an additional charge
- Multicolor upholstery also possible
- Base in white or titanium



- Height: 59 cm – 100 cm
- Length: 144 cm – 203 cm
- Width without / with armrests: 62 / 80 cm
- Lifting capacity: 200 kg
- Load capacity of the seat: 250 kg

SPL Neo

4-actuator



SPL Neo
with Standard upholstery



SPL Neo XP



SPL Neo with Soft upholstery



SPL Neo series

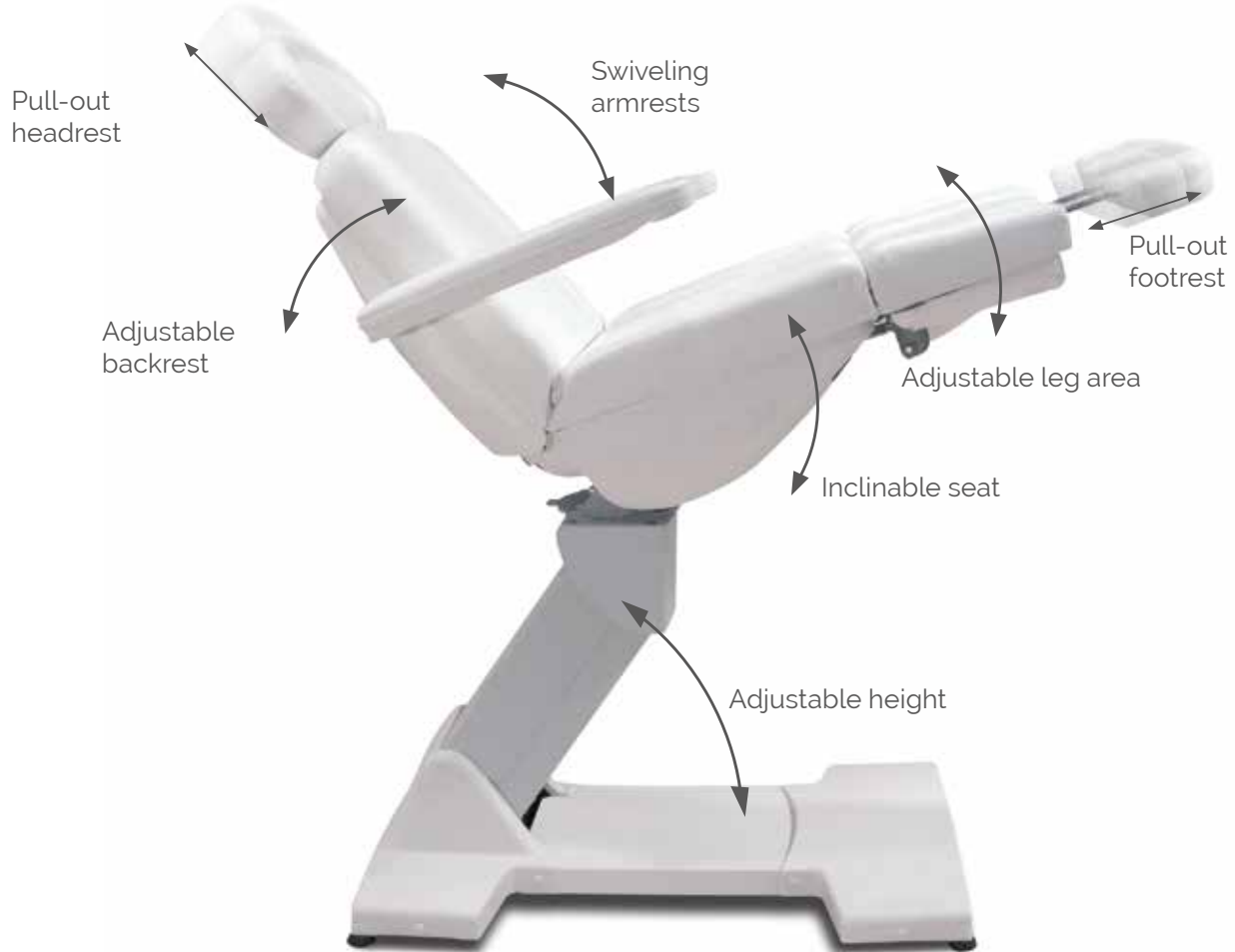

For all cosmetics treatments

The SPL Neo can be perfectly positioned for your cosmetic treatments. So you can adjust the chair height to 63-100 cm, set the backrest to 70°, tilt the seat by 25°, and adjust the leg range from

0 to -90°. Headrest and footrest can be extended by 10 cm and the armrests can be swiveled backwards.





Rotonde function

This feature allows the seat to be turned left or right by up to 180°. By means of the side-mounted locking it can be easily fixed in any position.



Headrest with XL extension

The adjustable and retractable XL extensions is a support surface for the arms, especially for prone body massages.



Manicure bowl

As with many other Gharieni treatment beds, the SPL Neo also allows the installation of a detachable manicure bowl on the armrest (Exception: Soft upholstery).



Footrest

This practical chrome-plated footrest protects the plastic casing of the base from mechanical wear and tear and dirt during head-side treatments.

Options (more info. after page 14)

	Soft Upholstery	---
	Thermo: Three-level heating system with automatic switch-off	---
	Vibro-Wellness: gently pulsating vibration system with many adjustment options	---
	Color upholstery:	
	PU (white or choco included in price), each color	---
	Synthetic leather standard, per color	---
	Synthetic leather Ferrari Stamskin Top, per color	---
	Synthetic leather Ferrari antibacterial coated, per color	---
	Logo embroidery: depending on effort,	---
	Multifunctional headrest:	
	Joint mounting, stainless steel	---
	Crescent-shaped attachment	---
	U-shaped attachment	---
	XL Extension Attachment to extend the table in the upper back area	---
	Color XL Extension: max. 2 diff. colors	---
	Synthetic leather standard, per color	---
	Synthetic leather Ferrari Stamskin Top, per color	---
	Rotonde (approx. 2 cm higher table access height): Seat rotatable by 180°	---
	Casing in titanium color	---
	Castor set, brakable, Art. 73006	---
	Wired foot switch with memory function Bluetooth® foot switch with memory function	---

Accessories (see also page 218)

	Terrycloth (white, black, macchiato, or choco)	---
	Dentalax neck rest	---
	Manicure bowl Holder	---
	Footrest	---
	Foot protective cover, PVC, transparent	---



Poliklinik Milojević

Zagreb, Croatia



SLR



Gharieni SLR

From the classical treatment position to massage setups – as a treatment bed, the SLR is multifunctional. Equipped for four actuators, you can electrically adjust the height, back, seat inclination, and leg section via a hand switch and in addition store four memory positions. The minimal width of the back section also allows for flexible working. Thanks to its mechanically retractable castors, the SLR is also easy to move.

At 58 cm, the bed provides a low starting height; and the anatomically-shaped, one-piece synthetic leather upholstery with its mechanical Airback offers your customers optimum comfort. The base of the SLR is available in a titanium with stainless steel elements. It comes standard with no armrests, this bed can also be optionally extended with various exchangeable and removable armrests.

Features:

- Minimal back width for flexible working
- Height, back, seat inclination, and leg section electrically adjustable via hand switch
- Hand switch
- Four storable memory positions
- Optionally, different removable armrest versions can be used
- Base in a titanium with stainless steel elements
- Low starting height
- Anatomically molded and made from one piece synthetic leather upholstery including "Airback" mechanical lumbar support system
- Standard upholstery color: White. Other colors from our color collection for an additional charge
- Mechanically retractable castors

SLR	
Without armrests	,-
Standard armrests	,-
PU armrests	,-



Without armrests



Standard armrests



PU armrests



- Starting height with inclined seat position: 48 cm
- Height: 58–85 cm
- Length: 188–210 cm
- Width without armrests: 64 cm
- (Recommended) lifting capacity: 200 kg
- Load capacity: approx. 250 kg

SLR



Suitably adjustable

The SLR can be adjusted according to your needs and those of your customers. In terms of height, the bed can be set to 58-85 cm. The seat can be inclined by 12°. The backrest can be tilted in relation to the seat from 0 to 75° and the leg section from 0 to

-80°. The headrest as well as the footrest can be extended by 10 cm. The armrests can be swiveled back and folded down for massage treatments.



Options (more info. after page 14)

-  Airback electrical: electro-pneumatic lordosis support system of the upholstery ,-,-
-  Thermo: Three-level heating system with automatic switch-off ,-,-
-  Vibro-Wellness: gently pulsating vibration system with many adjustment options ,-,-
-  Color upholstery:
Synthetic leather standard, per color ,-,-
Synthetic leather Ferrari Stamskin Top, per color ,-,-
Synthetic leather Ferrari antibacterial coated, per color ,-,-
-  Logo embroidery: depending on effort, ,-,-
-  Multifunctional headrest:
Joint mounting, stainless steel ,-,-
Crescent-shaped attachment ,-,-
U-shaped attachment ,-,-
-  XL Headrest ,-,-
-  Color XL Extension: max. 2 diff. colors
Synthetic leather standard, per color ,-,-
Synthetic leather Ferrari Stamskin Top, per color ,-,-
-  Wired foot switch with memory function ,-,-
Bluetooth® foot switch with memory function ,-,-



Variable PU armrests

The optional PU armrests, thanks to their special design, allow for use at variable heights. They can be effortlessly removed and used on opposite sides. This results in a high or low position for resting the arms. In addition, you can also remove the armrests altogether if the treatment requires it.



Mechanically retractable castors

Thanks to the mechanically extendable and retractable castors, the bed can be easily moved and safely positioned.



Locking function of the armrests

The armrests can be fixed parallel to the backrest or completely folded backwards. They automatically stay there in their final position.

Accessories (see also page 218)

- Terrycloth (white, black, macchiato, or choco) ,-,-
- Dentalax neck rest ,-,-
- Manicure bowl Holder ,-,-
- Foot protective cover, PVC, transparent ,-,-

Hydraulic series



Hydraulic models

Without actuators, but with total comfort: Our hydraulic models offer almost everything their siblings with actuators can. In the case of the PLS Cos and SL XP Hydraulic, the height, seat angle, backrest, and leg section can be adjusted using a pneumatic spring without much effort. The armrests can be swiveled backward for easier starting positions for customers; and the upholstery is available in many colors.

Features:

PLS Cos Hydraulic

- Height, seat inclination, back, and leg section adjustable via pneumatic spring
- Armrests fold backwards
- Inclinable head section
- Seat rotates 360°
- Synthetic leather comfort upholstery
- Standard upholstery color: White. Other colors from our color collection for an additional charge
- Also available as a Podo version

SL XP Hydraulic

- Height, seat inclination, back, and leg section adjustable via pneumatic spring
- Armrests fold backwards
- Pull-out foot and head sections
- Seat rotates 360°
- "Airback" lordosis support system
- Full-length ergonomic synthetic leather upholstery
- Standard upholstery color: White. Other colors from our color collection for an additional charge
- Also available as a Podo version

PLS Cos Hydraulic

- Height: approx. 59-79 cm
- Length: max. 144-203 cm
- Width without/with armrest: approx. 49/68 cm
- (Recommended) lifting capacity: 300 kg
- Load capacity of the table surface: 300 kg

SL XP Hydraulic

- Height: approx. 64-83 cm
- Length: approx. 144-203 cm
- Width without/with armrest: approx. 62/83 cm
- (Recommended) lifting capacity: 300 kg
- Load capacity of the table surface: 300 kg

PLS Cos Hydraulic

With pneumatic spring

,-,-



SL XP Hydraulic

With pneumatic spring

,-,-

Options PLS Cos (more info. after page 14)

- Color upholstery:
 - Synthetic leather standard, per color
 - Synthetic leather Ferrari Stamskin Top, per color
 - Synthetic leather Ferrari antibacterial coated, per color
- Logo embroidery: depending on effort,

Options SL XP (more info. after page 14)

- Color upholstery:
 - Synthetic leather standard, per color
 - Synthetic leather Ferrari Stamskin Top, per color
 - Synthetic leather Ferrari antibacterial coated, per color
- Logo embroidery: depending on effort,
- XL Extension: Attachment to extend the table in the upper back area
- Color XL Extension: max. 2 diff. colors
 - Synthetic leather standard, per color
 - Synthetic leather Ferrari Stamskin Top, per color
- Casing in titanium color
- Castor set, brakable, Art. 73006

Accessories (see also page 218)

- Terrycloth (white, black, macchiato, or choco)
- Dentalax neck rest
- Manicure bowl Holder (bei SL XP)
- Foot protective cover, PVC, transparent

Treatment Beds Accessories



Upholstery Covers

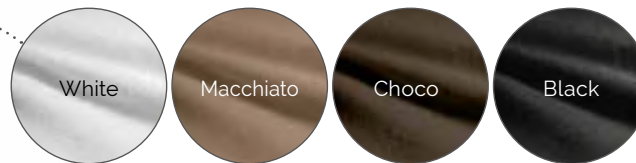

With the right covers your treatment bed will always be well protected against different types of stresses and strains. The table-specific covers are an exact match to the individual upholstery segments. With their integrated elastics, the parts of the terrycloth stay exactly where they belong, thus having no effect on the functioning of the bed.

Thanks to the high-quality material, machine washing up to 60°C is possible and therefore hygienic cleaning is possible. Our covers are available in white, choco, macchiato and black. It is best to order the right cover directly when you buy your table. Our team would be happy to help you decide!

Dentalax Neck Rest

This little accessory supports the neck and helps to stabilize the head. This creates a more comfortable table experience while relieving the neck vertebra. We recommend the Dentalax for each of our treatment tables as an optimal supplement for the best lying comfort and an increase in treatment ergonomics. The neck rest is available to match the upholstery color of the table.

Dentalax with PU, white	,-,-
Dentalax in PU, color	,-,-
Dentalax with synthetic leather, white	,-,-
Dentalax with synthetic leather, in standard colors	,-,-
Dentalax with synthetic leather, in Stamskin colors	,-,-



Roll holder including paper roll

The optional paper roller provides you with a practical, disposable protection for your table. This can easily be attached to the bed. As needed, the 50 cm wide paper is unrolled and pulled over the lying surface. After use tear it off at the perforation line and discard. A neat thing!

Roll holder including 1 paper roll, Art. 42064	,-
Sanitary paper roll, 50 x 0.5 m, Art. 42065, up to 8 pieces, ea.	,-
Sanitary paper roll, 50 x 0.5 m, Art. 42065, 9 pieces, ea.	,-



Foot protective cover

To protect the table areas at the foot end, we offer a suitable protective cover made of robust, transparent PVC for all tables. It can be securely fixed to the upholstery via Velcro.

Protective cover	,-
------------------	----



Neck/Knee rolls

To support a comfortable reclining position, we offer cylindrical and semi-cylindrical-shaped knee and neck rolls, each in two widths.

White, semi-cylindrical, 40 cm, Art. 42006/40	,-
White, semi-cylindrical, 60 cm, Art. 42006/60	,-
White, cylindrical, 40 cm, Art. 42005/40	,-
White, cylindrical, 60 cm, Art. 42005/60	,-

Manicure bowl

Practical manicure accessories: This drip tray can be easily attached to the armrests of most Gharieni tables (with the exception of double-upholstered and PU armrests).

Manicure bowl, Art. 42020	,-
Manicure bowl holder, Art. 42017	,-



mikrozyd® sensitive

For the gentle and thorough care of our upholstery we recommend mikrozyd® sensitive. Available as liquid or ready-to-use cloths in a handy dispenser, it eliminates bacteria, fungi, and viruses (such as HBV, HIV, Rota, vaccinia). Without alcohol!

mikrozyd® sensitive wipes, Art. 79418	,-
mikrozyd® sensitive liquid, Art. 79417	,-



Treatment units



Gharieni
Spa Trolley
HST



Gharieni
Spa Trolley
GST



Gharieni
Treatment unit
AluVap series



Gharieni
Shiro Dhara
Trolley series

Spa Trolley HST



Spa Trolley HST

Including steamer, Hot Cabi
and magnifying lamp



HST Trolley with
storable steamer

Gharieni Spa Trolley HST

Designed as an exclusive piece of furniture, this treatment unit not only offers a storable steamer with herbal diffuser, but also an FDS, or Foam Detecting System. This serves to shut off the steamer in the event of foaming by contamination. Also particularly practical are the swiveling steamer arm, a large storage space, an extendable tray, a drawer with subdivision, as well as a Hot Cabi compartment and a magnifying lamp holder. Equipped with four low-noise lightweight castors and available in numerous decors, the HST Spa Trolley is an indispensable and perfectly integrated work unit.

Features:

- Integrated steamer
- Swiveling steamer arm
- With herbal diffuser
- With FDS (Foam Detecting System) serves to shut off the steamer in the event of foaming by contamination.
- Pull-out tray
- Large storage space
- Drawer with subdivision
- Including Hot Cabi and magnifying lamp
- Hot Cabi compartment
- Magnifying lamp holder
- Storage compartment for Flex magnifying lamp
- Castors
- In numerous decors and different designs



- Height: 89 cm
- Width (closed): 50 cm
- Width (including steamer): 82 cm
- Depth (without handle): 48 cm
- Depth (including handle): 54 cm



Everything in one location

You'll see how practical the Spa Trolley is during your treatments: With its extendable tray, storage space, integrated steamer, magnifying lamp and Hot Cabi, it has everything you need for your cosmetic treatments. Thanks to its mobility, you have everything at hand during treatment. It doesn't get any more practical!



Storable steamer

For organization in your workspace: When not in use, simply let the steamer and magnifying lamp "disappear" into the back of the spa trolley.



Integrated Hot Cabi

Best organized: A Hot Cabi is integrated into the lower compartment of the HST. This means that your warm compresses are always on hand.

Spa Trolley GST

Gharieni Spa Trolley GST

This treatment unit is exclusive and practical in the form of a trolley. This piece of furniture offers everything that makes your job easier: a storable swivel-mounted steamer, a herbal diffuser, and the Foam Detecting System (FDS) to shut down the steamer in the event of foaming by contamination. Also, the large storage space with four drawers, which can be divided in different ways according to what you want, proves itself in all treatments. In addition, the integrated Hot Cabi offers warm towels at hand. What's more, a magnifying lamp holder and a storage compartment for the Flex magnifying lamp make the Spa Trolley GST the optimal work partner for you and in any desired location at that! Thanks to the low-noise, lightweight castors, you can easily push the Spa Trolley anywhere you need it. And last, but not least: Available in numerous decors, the Spa Trolley GST can also be perfectly integrated into any studio or workspace interior.

Features:

- Integrated steamer with herbal diffuser
- FDS (Foam Detecting System) serves to shut off the steamer in the event of foaming by contamination.
- Swiveling steamer arm
- Large storage space
- Drawer with variable partitioning system
- Hot Cabi compartment
- Magnifying lamp holder
- Storage compartment for Flex magnifying lamp
- Castors
- In many decors
- Including Hot Cabi and magnifying lamp



Spa Trolley GST

Including steamer, Hot Cabi
and magnifying lamp

- Height: approx. 117 cm
- Width (closed): approx. 70 cm
- Width (including steamer): approx. 109 cm
- Depth: 50 cm



Extensive storage space

With its numerous different drawers and compartments, the trolley offers perfect organization for any workspace.



For secure positioning

Thanks to the flexible drawer divider, the space in the drawers can be individually divided as needed. That way nothing can tip over when opening and closing drawers.



Drawer dividers

The changeable dividing interior of the drawers allows for convenient and clear organization of small instruments and preparations.



Steamer with many functions

The steamer is not only equipped with a herbal diffuser, but also with a Foam Detecting System (FDS). This shuts off foaming in the event of contamination.



Integrated steamer

As soon as you no longer need the steamer, you can stow it away in the Trolley. Simply swivel it into the appropriate storage compartment.



Practical with Hot Cabi

Thanks to the integrated Hot Cabi, warm towels and compresses are always at hand.

AluVap



- Height: approx. 100 cm
- Steamer arm reach: approx. 70 cm
- Base diameter: approx. 46 cm

Gharieni AluVap

The space-saving AluVap treatment unit is your ideal partner in professional cosmetics. Made of sturdy, high-quality aluminum, it offers all the functions for modern cosmetic treatments even in the smallest of spaces. Because of its modular structure, the device configuration can be put together individually. Four modules can be integrated as needed, such as Peeling, Vac/Spray, Iono, High-frequency, and Rotating Drawer. In addition, the steamer can be expanded by an aroma or herbal option. Another highlight is the LED colored light option. This LED technology turns the steamer into an exclusive "face bio sauna." Depending on the color choice, the light enhances the psychological well-being of your customers. Thus, depending on your needs, it can have a relaxing, regenerating, balancing, stress-relieving, or revitalizing effect.

Additional equipment extras also include an Ultrasound and a Hot/Cold device, as well as a magnifying lamp in different versions.

Available standard in white, black-brown, or with a titanium, you can also choose from more than 200 RAL colors. This perfect treatment unit can thus also be color-matched to integrate into any workspace.

Features:

- Compact construction
- Slim Rotary-shaped design
- Aluminum body
- Modular construction
- Assembled according to your needs
- Up to four modules to choose from
- Large radius of action
- Easy-to-use
- Short heating-up phase
- Swiveling steamer arm
- Water supply via funnel from above
- Easy to remove water tank
- Felt ring for aroma treatment
- Herbal diffuser (optional)
- Can be expanded with additional devices, magnifying lamp, and other accessories
- Comes standard in white, black-brown, and with a titanium
- Other colors possible for an additional charge

Configurator

The following modules can be used to create your own personal treatment unit:

Basic module

Base including power block	,-
Wood decor base	,-

AluVap steamer

AluVap steamer	,-
Herbal option	,-
Colored light	,-

Modules (choose from a total of four)

Peeling	,-
Vac/Spray	,-
Iono	,-
High-frequency	,-
Rotating drawer	,-

Additional devices

Hot/Cold	,-
DeLuxe Plus magnifying lamp LED, white, Art. 41837WELED	,-
DeLuxe Plus magnifying lamp LED, black, Art. 41837SWLED	,-
Adapter for magnifying lamps	,-

Accessories

Felt rings, 10 pieces, Art. 90318	,-
-----------------------------------	----



For modules to choose from

Whether it's with Peeling, Vac/Spray, Iono, High-frequency, or Rotating Drawer – configure the treatment unit with up to four perfectly matching modules according to your needs.



Colored light

The optionally available colored light for the steamer head of the AluVap is the perfect addition: Depending on your choice of color, the light has a relaxing, regenerating, balancing, stress-relieving, or revitalizing effect.



Device holder

With this special holder you can place handpieces and their accessories, which you need for your treatments, near the AluVap treatment unit. – For particularly practical and efficient work.



Basic module base

The base of the basic module is equipped with braked castors and is available in metal as standard. For a particularly high-end look, you can also optionally choose from one of our numerous wood decors.

AluVap

Versions:



AluVap steamer

The simplest version: The AluVap steamer without additional devices with rotating storage compartments.

AluVap with steamer, without devices -,-



AluVap workstation

Also without steamer, as an equipment trolley, the AluVap cuts a fine figure. With its slim design, it has the right device for every application.

AluVap with devices, without steamer -,-

Gharieni AluStyle

Based on the Rotary design of the AluVap, the devices from our treatment units are also available individually in robust aluminum housing. With their non-slip base and compact design, the AluStyle devices fit on almost all furniture items and equipment trolleys.

Features

- Robust aluminum housing
- Continuous adjustment, partly with illuminated display
- Exclusive lamp elements
- Exclusive Rotary design

Peeling AluStyle

- Including a soft 20 mm and 45 mm brush
- Including a hard 45 mm brush
- Sponge holder including ten small sponges

Vac/Spray AluStyle

- Including one round, flat, and curved ventouse and a large and small suction cup
- With two spray bottles and hose set

High-frequency AluStyle

- Including one 20 mm and 45 mm round electrode, one neck electrode, and one indirect electrode

Iono AluStyle

- Including one hand and two roller electrodes



AluStyle Peeling

Art. 91300



AluStyle Vac/Spray

Art. 91301



High-frequency AluStyle

Art. 91302



AluStyle Iono

Art. 91303



Shiro Dhara series



Shiro Dhara Trolley Wood
in black-brown --
in chrome --



Shiro Dhara Trolley Junior
in chrome/titanium --

Gharieni Shiro Dhara Trolley series

There are two models available for deep relaxing ayurvedic oil forehead pouring:

The Shiro Dhara Trolley Wood with a base featuring wood decor is equipped with a tray for various collection containers and an oil drainage device with collection glass. These elements are height adjustable.

On the Shiro Dhara Trolley Junior, the forehead pouring bowl has an adjustable valve. The arm and (on request several) trays are height adjustable; and the tray bottoms can be selected in wenge, glass, or wood.

Features

Shiro Dhara Trolley Wood:

- Base in wood decor
- With tray and oil drainage device including collection glass
- Different collection containers available
- Height-adjustable elements
- Castors
- Available in chrome colors and black-brown

Shiro Dhara Trolley Junior:

- For oil forehead pouring
- Trays and arm height adjustable
- Choose from glass or wenge wood for tray bottoms
- Forehead pouring bowl with adjustable valve and suspension device
- Expandable with two additional trays
- Brakable castors
- Available in chrome/titan

Accessories

Additional tray in glass or wood decor including holder



- Height: approx. 178 cm
- Wood base width: approx. 55 cm
- Junior base width: approx. 70 cm



Elegant forehead pouring bowl

The forehead pouring bowl of the Shiro Dhara Trolley Junior is equipped with an adjustable valve. This makes it easy to regulate the flow rate. The holder for the forehead pouring bowl is height adjustable.



Oil collection device

The Shiro Dhara Trolley Wood includes an oil drainage device with collection glass... This makes it easy to collect and dispose of the returning oil – for convenient and clean work.



Oil bowl

The Shiro Dhara trolley collects the returning oil in a stainless steel bowl. The tray for the bowl is height adjustable and can be optionally equipped with glass or wood decor bottom.

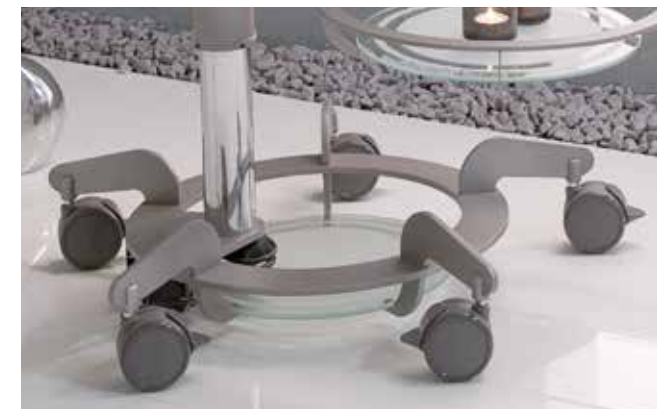

Easy-rolling castors

The five lightweight castors of the Shiro-Dhara-Wood and Junior models ensure perfect mobility and stability. This way you can easily move the trolley anywhere you need it.



Photo: © Katrina Lawson Johnston

Dr Barbara Sturm

London/
Los Angeles



Photo: © Katrina Lawson Johnston



Photo: © Katrina Lawson Johnston



Photo © Katrina Lawson Johnston



Photo © Katrina Lawson Johnston



Photo © Katrina Lawson Johnston

Furnishings

Furniture series



Gharieni
K8



Gharieni
K10

Equipment trolley series



Gharieni
MLX Trolley



Gharieni
MO Trolley



Gharieni
Square Trolley



Gharieni
Kg Trolley



Gharieni
GL

Manicure tables

Gharieni
ManoGharieni
Cube Select

Stools + Chairs

Gharieni
CubeGharieni
VarioGharieni
Lamica

K8 Furniture series



Gharieni K8 Sideboards

The K8 series provides aesthetic design for your treatment cubicle; because the elements of this modular system are enclosed by a joint-free frame. According to your needs and the size of your workspace, the basic frame module is available in four versions: for one, two, three, or four individually assembled built-in modules in a width of 107 to 207 cm. With the built-in elements – a drawer, cabinet, and floor unit module – you can also choose according to your needs.

Features:

- In four widths: up to four modules
- Individually assembled built-in modules
- Choose from various wood and color decors
- Also as a washbasin cabinet version
- Additional attachment basin possible
- Optionally with LED lighting



K8 Sideboard with 1 module

Without lighting	,-,-
With lighting	,-,-



K8 Sideboard with 2 modules

Without lighting	,-,-
With lighting	,-,-



K8 Sideboard with 3 modules

Without lighting	,-,-
With lighting	,-,-



K8 Sideboard with 4 modules

Without lighting	,-,-
With lighting	,-,-

K8 Sideboard with 1 module

- Height: 94.5 cm
- Width: 57 cm
- Depth: 60 cm

K8 Sideboard with 2 modules

- Height: 94.5 cm
- Width: 107 cm
- Depth: 60 cm



K8 Sideboard with 3 modules

- Height: 94.5 cm
- Width: 157 cm
- Depth: 60 cm

K8 Sideboard with 4 modules

- Height: 94.5 cm
- Width: 207 cm
- Depth: 60 cm

K8 Furniture series

Optional:
LED lighting



Optional:
Attachment basin
Including fittings



Optional LED bar

The integrated LED bar provides sophisticated lighting along the upper frame surface.



For perfect organization

For easy disposal of used textiles, the drawer of the K8 laundry module can be equipped with a removable laundry basket.

K8 frame:



K8 frame for 1 module

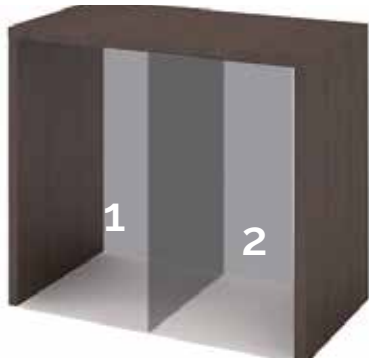

K8 frame for 2 modules

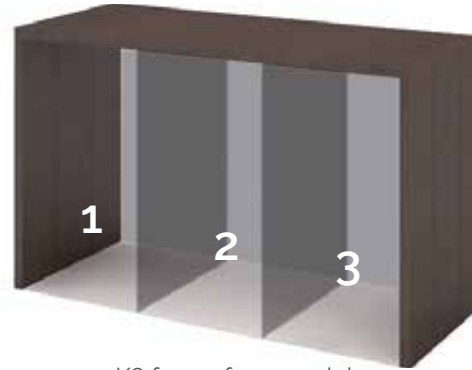

K8 frame for 3 modules

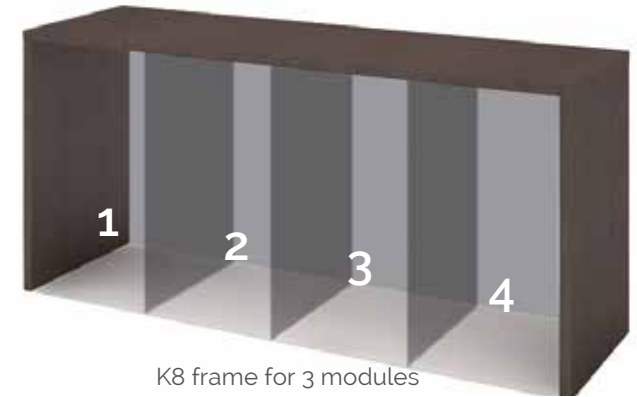

K8 frame for 4 modules



K8 built-in modules



K8 drawer module



K8 laundry module



K8 floor unit module



Basin, round
Including fittings



Basin, rectangular
Including fittings



Organizer, white



Waste container, 11 l



Waste container, 5 l



Laundry basket



Waste container, 11 l



Waste container, 5 l



Laundry basket



K10 Furniture series



Gharieni K10 Sideboards

The K10 furniture series is the innovative development of the successful K9 series. As a modular system with a frame that can include up to four built-in modules, the K10 series offers perfect, aesthetic organization for your workspace. According to your needs, you can assemble your K10 Sideboard from the following modules:

a drawer, cabinet, and floor unit module. The Spa Trolley HST treatment unit K10 module, which can be perfectly integrated, is particularly practical. This module on noiseless lightweight castors can be easily pulled out for treatment and then pushed back into the unit.

Features:

- In three versions: with two, three, or four modules
- Individually assembled built-in modules
- Choose from various wood and color decors
- Also as a washbasin cabinet version
- Additional attachment basin possible

K10 Sideboard with 4 modules

- Height: 93 cm
- Width: 207 cm
- Depth: 60 cm



K10 Sideboard with 3 modules

- Height: 93 cm
- Width: 157 cm
- Depth: 60 cm

K10 Sideboard with 2 modules

- Height: 93 cm
- Width: 107 cm
- Depth: 60 cm



K10 Sideboard

With 4 modules



K10 Sideboard

With 2 modules



K10 Sideboard

With 3 modules



K10 Furniture series



Spa-Trolley HST



Equipment-Trolley HST

Trolley-HST modules for K10 furniture

These modules are available in two versions: As a Spa-Trolley HST with retractable steamer and Hot Cabi for your treatments (see Seite 252), as well as Equipment Trolley with Hot Cabi and drawers for practical storage space.



Spa & Equipment-Trolley HST

The treatment trolleys can be easily inserted under the frame when not in use and thus form a solid unit with it.

K10 frames:



K10 frame for 4 modules



K10 frame for 3 modules



K10 frame for 2 modules



K10 Built-in modules (permanently installed):

K10 Drawer modules



K10 Cabinet modules



K10 Trolley modules (pull-out, on castors):

K10 Drawer Trolleys



K10 Equipment-Trolley HST with integrated Hot Cabi



K10 Spa-Trolley HST with integrated steamer, Hot Cabi and magnifying lamp



K10 handles:

Choose the right handle for your K10 furniture! There are four different models available for this purpose – recessed shell handles, an attached bar handle, or attached bow handles made of metal or with leather insert.



Shell handle

- Recessed handle
- Aluminum
- Chrome-plated, matte

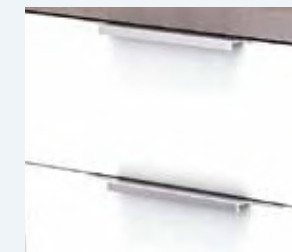

Bar handle

- Attached bar handle
- Zinc die-casting
- Aluminum-colored



Furniture handle leather

- Attached handle strip
- Zinc die-casting chrome-plated, matte
- Lining: Leather

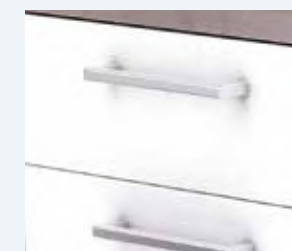

Furniture handle stainless steel

- Attached handle strip
- Stainless steel
- Brushed matte

K10 Furniture series

Gharieni K10 Presentation Showcase

With the refined and discreetly illuminated showcase with glass cover, for example, you can show your premium products "in the right light" in an appealing and classy fashion. And for your very own personalized look, the logo of your institute can be featured on the front of the showcase.

Features:

- Glass cover to protect the products
- Pull-out tray
- High-end bi-color design
- Choose from various wood and color decors
- Including illuminated frame
- Enough room for your personalized logo on the front side

K10 Presentation Wall

Put your goods in the spotlight with the K10 Presentation Wall. The modern, purist appearance of the Wall in an individual wood decor or a color surface of your choice, together with the subtly refined illumination is absolutely high-end and allows for a perfectly professional presentation of your products.

Features:

- Three shelves
- Including backlight illumination for discreet lighting
- Exclusive bi-color design or monochrome
- Choose from various wood and color decors



K10 Presentation Showcase

Including LED lighting -,-

Individual logo -,-



K10 Presentation Wall

Including LED lighting -,-

K10 Presentation Showcase

- Height: 116 cm
- Width: 40 cm
- Depth: 40 cm



K10 Presentation Wall

- Height: 230 cm
- Width: 160 cm
- Shelf depth: 40 cm

Gharieni K10 Reception Counters

First impressions count! Therefore, welcome your customers right in your entrance area with a visual highlight. Our K10 Reception Counters offer everything you need: ample storage space for everything you need at reception and plenty of additional storage space. In addition, a subtle illumination of the front frame and a personal branding on the large front surface are possible. With an individual wood decor or color surface and the two selectable sizes, the K10 Counters fit in almost every reception area.

Features:

- Available in two sizes
- Various drawers and compartments for keyboard, computer, and materials
- Exclusive bi-color design
- Choose from various wood and color decors
- Illuminated frame on the front
- Enough room for your personalized logo on the front side

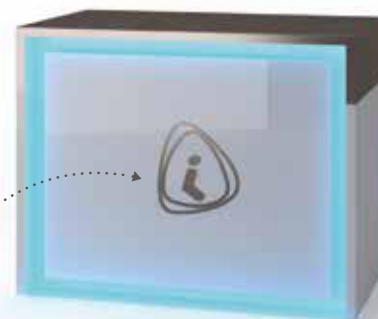

Your Logo can be placed here

K10 Reception Counter, small	
Including LED lighting	,-
Individual logo	,-

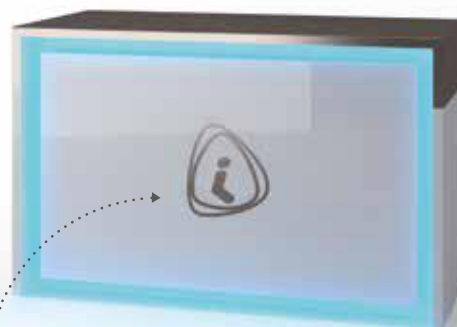

Your Logo can be placed here

K10 Reception Counter, large	
Including LED lighting	,-
Individual logo	,-



K10 Reception Counter, small

- Height: 90 cm
- Width: 120 cm
- Depth: 70 cm

K10 Reception Counter, large

- Height: 90 cm
- Width: 160 cm
- Depth: 70 cm

The St Regis Dubai The Palm UAE





Photos: © The St Regis Dubai The Palm

MLX Trolley series



MLX Trolley versions

No matter for what purpose: Choose your suitable MLX Trolley from our offering!



Large (Height: approx. 99 cm)

Medium (Height: approx. 88 cm)

Small (Height: approx. 77 cm)

Mini (Height: approx. 55 cm)

MLX Trolley

Do you love to work when things are "tidied up" and are organization and clarity a must for you in your workspace? Then the multifunctional MLX Trolley is just right for you!

Whether you opt for a small, medium, or large Trolley, combine low and high Tip-On drawers, as it best suits you. Practical, too: With the all-round handle and the high-quality lightweight castors, the trolley can be moved effortlessly. In addition, it can be equipped with a magnifying lamp holder on request. Also: Thanks to the possibility of choosing from a variety of matte and glossy color and wood decors, the trolley is a perfect fit in every workspace!

Features:

- Multifunctional trolley
- Combination of high and low Tip-On drawers
- All-round handle
- Choose from a large variety of versions and designs
- High-quality castors
- Optionally with magnifying lamp holder

Accessories

Tray attachment	,-,-
Magnifying lamp adapter, integrated, Art. 41812V2	,-,-
Magnifying lamp adapter, side assembly, Art. 41804	,-,-



- Height: 76.5 cm (small), 88 cm (medium), 99 cm (large)
- Width without handle: 45 cm
- Width including handle: 54 cm
- Depth without handle: 45 cm
- Depth including handle: 54 cm



Tip-On drawers

Just tap it a little bit: The Tip-On technology allows you to effortlessly open the drawers.



Tray attachment

Everything at hand with the optional detachable tray attachment. This allows you to provide the necessary products for your treatments and at the same time use the tray as a storage surface.



Railing

With its all-round handle in a look of your choice, the MLX Trolley is "at hand" in the truest sense of the word from all sides. In this way, it can be pushed anywhere where you need it.



Magnifying lamp holder

Optionally, the MLX Trolley can also be equipped with a holder for a magnifying lamp. In this way your "mobile storage space" offers the possibility of the right lighting for your treatments at the same time.

MLX Trolley series



MLX Display Trolley Plus	
Including Hot Cabi Maxi	-,--
Display lighting	-,--



MLX Display Trolley	
Without Hot Cabi	-,--
Display lighting	-,--

Gharieni MLX Display Trolley

The MLX Display Trolley features side compartments with flap, a fold-out compartment, and a drawer in the front area as well as a Hot Cabi compartment for optimal storage space.

With an optional illuminated display, you can also perfectly present your preparations. Of course, you can also choose your decor from a variety of colors and textures to suit your taste in these elegant designer pieces. The Display Trolley is available in two versions: narrow and as a wider Plus version including a Hot Cabi.

Features:

- Fold-out compartment and drawer in the front area
- Side compartments
- Optional illuminated display for attractive placement of your preparations
- Available in different decors
- Lightweight castors
- All-round handle

Accessories

Tray attachment	,-
Magnifying lamp adapter, integrated, Art. 41812V2	,-
Magnifying lamp adapter, side assembly, Art. 41804	,-

MLX Display Trolley

- Height: 99 cm
- Width (without handle): 45 cm
- Width (including handle): 54 cm
- Depth (without handle): 45 cm
- Depth (including handle): 54 cm



MLX Display Trolley Plus

- Height: 99 cm
- Width (without handle): 50,5 cm
- Width (including handle): 60 cm
- Depth (without handle): 52 cm
- Depth (including handle): 62 cm



Hot Cabi

The wider display Trolley Plus has a standard integrated Hot Cabi. This way your warm compresses are always at hand.



Side storage compartments

For practical working: Reachable from both sides, the side storage compartments offer quick access. With the Display Trolley Plus, the storage compartments can also be closed with a flap.



Lighting display

For optimal product presentation and a sophisticated appearance, the base plate can be equipped with lighting.



Tip On

A light press is all it takes: Thanks to the Tip-On technology, the drawers open effortlessly and quietly.

MLX Trolley series



MLX Wax Trolley
Including wax heater ---



MLX Wax Trolley Plus
Including 1 wax heater ---
Including 2 wax heaters ---

Gharieni MLX Wax Trolleys

The flexible MLX Wax Trolleys with lightweight castors offer simple and clean depilating: In the upper compartment there is an integrated wax heater and recesses for wax cans. The integrated folding waste container allows for easy disposal. The full-length storage compartment in the back area permits access from both sides. The MLX Wax Trolley Plus can also store a supply of three wax pistols in the middle drawer. The Trolleys are available in various decors.

Features:

- With integrated wax heater
- Optional second wax heater possible
- Extendable compartment e.g for wax pistols on the MLX Wax Trolley Plus
- Cover can be pushed back and used as a storage area
- Side storage compartments
- Practical folding waste container
- Available in different decors
- On castors

Accessories

Magnifying lamp adapter, side assembly, Art. 41804

--



- Height: 98 cm
- Width without handle: 45 cm
- Width including handle: 54 cm
- Depth (without handle): 45 cm
- Depth (including handle): 54 cm



Practical cover

The wax heater integrated in the upper compartment and the wax can recesses are covered by a sliding plate. When opened, this can be used as a practical storage space.



Drawer for wax pistols

In its extendable middle drawer, the MLX Wax Trolley Plus offers the possibility to accommodate three wax pistols.



Integrated hinged waste container

The integrated hinged waste container in the MLX Wax Trolley makes it easy to dispose of your consumables.



Side storage compartments

For practical working: Reachable from both sides, the side storage compartments offer quick access.

MO Trolley



MO Trolley
Including 4 insert baskets

Gharieni MO Trolley

Our MO Trolley provides clear design and lots of storage space with its spacious drawer and the large storage baskets. Thanks to its invisible castors, the Trolley can be positioned anywhere it is needed. With its different wood and color decors, it not only fits into any ambience, but thanks to its design, also perfectly matches our MO1 spa tables.

Features:

- Mobile trolley
- Compact, low construction
- With a spacious drawer
- Pull-out shelf for devices or preparations
- Drawers with soft-close technology
- Sturdy metal baskets for secure storage
- Available in different decors
- Lightweight, invisible castors

Accessories

Magnifying lamp adapter, side assembly, Art. 41804



Stable storage baskets

The aluminum baskets specially made for the MO Trolley ensure safe storage; Rubber feet effectively prevent slipping. When not in use and during cleaning, the shelves can be easily removed.



Gently closing drawers

The spacious drawers offer plenty of space for your work instruments and equipment. Also: Thanks to their Soft-close technology, the drawer and pull-out shelf close quietly and gently.



- Height: 68 cm
- Width: 61 cm
- Depth: 46 cm

Square Trolley



Square Trolley
Complete -,-

Gharieni Square Trolley

This mobile preparation trolley is the practical helper for all your treatments. The side compartments and two drawers in the front area allow you to store everything you need. An extendable tray in the front provides a useful storage space; The folding compartment stores used materials and the side handles can be used as towel holders. Equipped with castors, the Trolley can effortlessly and quietly move to any desired place. And if the Square Trolley is to be used with a magnifying lamp, it can be optionally equipped with a magnifying lamp holder.

Features:

- Mobile preparation trolley
- Two drawers in the front area
- Drawers with Tip-On-Technology
- Side compartments
- Fold-out compartment for waste
- Handles on the sides that can be used as towel holders
- Pull-out tray
- Available in different decors
- On castors
- Optionally with magnifying lamp holder

Accessories

Magnifying lamp adapter, integrated, Art. 41812V2	---
Magnifying lamp adapter, side assembly, Art. 41804	---



- Height: approx. 82 cm
- Width (without handle): 45 cm
- Width (including handle): 54 cm
- Depth: 45 cm



Pull-out tray

The extendable tray offers a convenient storage area for all treatments.



Drawer with Tip-On-Technology

The drawers can be easily opened with their Tip-On-Technology with the touch of a finger.



Integrated fold-out compartment

Used materials can be disposed of immediately in the fold-out compartment in the front.



Side storage compartments

The side compartments accessible from both sides provide additional practical storage space.

Four Seasons Hotel at The Surf Club Surfside, Florida, USA





K9 Trolley



K9 Trolley
On castors

Gharieni Kg Trolley

The cosmetic trolley Kg offers four spacious drawers and thus enough space for your practical work. The modern Tip-On technology facilitates the use of the trolley: with light pressure, the drawers slide out smoothly and quietly. The elegant handle and smooth-running wheels make it easy to push the trolley into the required position. And for the right look, choose from a variety of wood and color decors in matte or high-gloss!

Features:

- four spacious drawers
- smooth sliding out of the drawers by tip-on automatic
- elegant handle for moving the furniture
- rubberized castors

Accessories

Magnifying lamp adapter, integrated, Art. 41812V2	---
Magnifying lamp adapter, side assembly, Art. 41804	---



Kg Trolley

- Height: 81.5 cm
- Width: 66 cm
- Depth: 43 cm



Various designs

The Kg Trolley is available in various designs. Elegant wood / color combinations are also possible. Thus, he fit into any ambience.



Drawer with Tip-On-Technology

The drawers can be easily opened with their Tip-On-Technology with the touch of a finger.



Chrome handle for moving

With a practical chrome handle on the front, the CL Trolley can be moved effortlessly...



On casters

With its smooth-running wheels, the Kg Trolley can be moved easily and quietly. Due to the rubber coating of the rolling surfaces, the floor covering is protected.

GL Trolley series



GL60 Trolley
Art. 35120



GL45 Trolley
Art. 35121



GL Square Trolley
Art. 35117

Gharieni GL Trolley series

The GL Trolleys are equipped with a practical pull-out shelf for various devices and three drawers. In different sizes, it offers you the storage space that you need for tidy work.

Comes standard in white or wenge, but other decors are also optionally possible. On request, the Trolley is also available with a magnifying lamp holder. Four large rubber castors, two of which are brakable, make the GL Trolley mobile.

Features:

GL 60/45 Trolley

- Pull-out shelf for various devices
- Three drawers
- Four large rubber castors, of which two are brakable
- In five standard decors (see page 17), optional in other decors
- Optionally with magnifying lamp holder

GL Square Trolley

- Pull-out shelf for various devices
- Three drawers
- Four large rubber castors, of which two are brakable
- In five standard decors (see page 17), optional in other decors
- Optionally with magnifying lamp holder

Accessories

Magnifying lamp adapter, side assembly, Art. 41804

--

GL60 Trolley

- Height: 80 cm
- Width: 60 cm
- Depth: 40 cm



GL45 Trolley

- Height: 80 cm
- Width: 45 cm
- Depth: 40 cm

GL Square Trolley

- Height: 102 cm
- Width: 40 cm
- Depth: 42 cm



Removable storage shelf

The removable storage shelf provides space for devices or your work instruments.



Suitable for magnifying lamp

The optional magnifying lamp holder allows you to equip the trolley with the right lighting for your treatments.



Space for one Hot Cabi

The Trolley GL Square offers the possibility to integrate a Hot Cabi.



Spacious drawers

Three drawers provide ample storage space, so you can accommodate all the important things for your work.

Cube Trolley series



Cube Select Trolley	
With castors	,-,-
Without castors	,-,-
Base in chrome, additional charge	,-,-

Gharieni Cube Select

With the Cube Select trolley, you can choose between two equipment variants: a large-capacity drawer or two medium-sized drawers. In the version with smooth-running wheels, the Gharieni Cube Select can be moved wherever you need it. With its noble metal-wood combination - from five standard decors and its metal base in white, titanium look, black-brown or optionally in chrome - this practical trolley looks extremely classy. It is also available in other décor variants on request.

Features:

- Optionally with a large drawer and two spacious inner surfaces or with two medium-sized drawers
- High-end metal-wood combination
- In five standard decors (see page 17), optional in other decors
- Metal base with round column in white, titanium, or black-brown
- Large lightweight castors
- Also without castors
- Optional metal base in chrome available
- Additional decor versions optional

Accessories

Magnifying lamp adapter, integrated, Art. 41812V2	-,-
Magnifying lamp adapter, side assembly, Art. 41804	-,-



- Height with castors: 81 cm
- Width: 41 cm
- Depth: 43 cm



Various drawers

With the Cube Select, you can choose between a large-capacity drawer with two spacious inner compartments or two medium-sized drawers.



Elegant metal base

The metal base with its slim, round column makes the trolley look very light. Available in white, black-brown, titanium, and chrome.



With or without castors

In addition to the large lightweight castors, the Cube Trolley can be equipped with a simple stationary stand.



Matching: Manicure table Cube

On page 274 in this catalog you will also find the matching manicure tables from our Cube series.

Vario series



Vario Select

- With doors
- Without doors



Vario Square

- With doors
- Without doors



Gharieni Vario Series

The Vario Square and Vario Select trolleys offer a wide range of options for practical work in any location. The upper shelf can be swiveled to the side and the inner shelves can be mounted at different heights as required. Depending on your needs, a Hot Cabi or Hot Stone Warmer can also be optionally integrated into the Vario Square.

Our wide decor range also gives you the opportunity to adapt the trolley perfectly to your ambience.

Features:

- Upper shelf can be swiveled laterally
- Inner shelves can be mounted at different heights
- Installation of a Hot Cabi or Hot Stone Warmer optional
- In five standard decors (see page 17), optional in other decors
- Metal parts in white, titanium, or black-brown
- Special equipment possible
- with lightweight castors



Sophisticated curves or classical square

Its curved metal parts give the Vario Select a particularly elegant look. However, the Vario Square appears classically straight with its angular edges. The choice is yours!



Swiveling shelves

The top compartment holds a Hot Cabi or a Hot Stone Warmer. The split cover can be swiveled sideways. This gives you access to the Hot Stone Warmer from the top.



Storage space

The shelves inside the cabinet are individually mountable. Instead of the Hot Stone Warmer, other devices such as our small Hot Cabi can be installed.



- Height: 80 cm
- Width (closed): 70 cm
- Width (with open panels): 130 cm
- Depth: 43 cm

Lamica Trolley series



Lamica Decor Line Trolley

With 2 tray compartments	7,--
With 3 tray compartments	7,--
Drawer	7,--



Lamica Wood Decor Trolley

With 2 tray compartments	7,--
With 3 tray compartments	7,--
Drawer	7,--



Lamica Glass Decor Trolley

With 2 tray compartments	7,--
With 3 tray compartments	7,--
Drawer	7,--
Glass drawer holder	7,--

Gharieni Lamica Trolley

Do you need a versatile trolley in your workspace? Then the Lamica model is just right for you! Because the trolley can be customized. This way you can choose from two or three shelves as well as a drawer. In addition, it can be equipped with a sanitary container with holder.

The design can also be chosen as desired: The shelves are available with an elegant glass and wood look or in classical white. The frame is available in titanium, black-brown, white or chrome; and the large lightweight castors are color-matched to it.

Features:

- With two or three shelves
- With railing
- With or without drawer
- In a sophisticated glass and wood look or in classical white
- Frame in titanium, black-brown, white or chrome-plated
- On large, color-matched lightweight castors
- Optionally with magnifying lamp holder,

Accessories

Magnifying lamp adapter, Art. 41820

,-,-

Water bowl with holder, Art. 41180

,-,-



Optional magnifying lamp holder

For practical work, the trolley optionally offers a holder for a magnifying lamp. In addition to your work instruments, you will always have the right lighting in your area.



Optional collection container

Used material can be stored in the stainless steel bowl attached to a holder. For best positioning, the holder can be adjusted horizontally and vertically.



Lamica Wood Decor Trolley

- Height with 2 shelves: 76 cm
- Height with 3 shelves: 94 cm
- Width: 65 cm
- Depth: 42 cm

Lamica Decor Line Trolley

- Height with 2 shelves: 76 cm
- Height with 3 shelves: 94 cm
- Width: 59.5 cm
- Depth: 42 cm

Lamica Glass Decor Trolley

- Height with 2 shelves: 79 cm
- Height with 3 shelves: 95.5 cm
- Width: 65 cm
- Depth: 42 cm



Optional drawer

On request, the Lamica can also be equipped with a drawer to match the look.

Cashel Palace Cashel, Ireland





Mano



Mano manicure table
Glass top in white or black

Gharieni Mano

This manicure table looks particularly light and elegant with its special curved glass top. The practical drawer container with its easy-open Tip-On compartments offers space for everything you need for a manicure. And of course, the manicure table also has an integrated lamp holder.

When it comes to design, the Mano leaves nothing to be desired. Thus you can choose its glass top in white or black and the metal parts in white, titanium, or black-brown. So that the Mano optimally matches the ambience of your workspace, we have a large collection of wood decors ready for you.

Features:

- Worktop made of special curved glass
- With drawer container
- Drawers with Tip-On-Technology
- With black or white glass top
- Container available in different wood decors
- Metal elements in white, titanium, black-brown
- Integrated lamp holder (without lamp)

Accessories

Slimline LED working light, Art. 41820



- Height: 79,5 cm
- Width: 129 cm
- Depth: 57 cm



For perfect lighting

The integrated lamp holder is suitable for our Slimline LED working light. This not only ensures optimal lighting, but also a visually compelling overall appearance.



Large amount of space

With three drawers, the Mano container provides ample space for all the tools you need for a manicure.



Curved glass top

The curved plate made of special glass in black or white looks light and sophisticated at the same time.



Just simply Tip-On

A slight pressure is all it takes and the drawers open quietly. As a result, no handles are needed. This creates a clean look.

Cube Select



Cube Select manicure table

Metal parts in standard colors	---
Metal parts in chrome	---



Cube Select Duo manicure table

Metal parts in standard colors	---
Metal parts in chrome	---

Gharieni Cube Select

The Cube Select manicure table looks very sophisticated with its metal-wood combination. With five standard decors and its round metal base in white, titanium, black-brown, or chrome (optional), it integrates into any workspace ambience. Upon request, it is additionally available in other decor versions. Choose the manicure table with one maxi or two medium-sized drawers with soft-close.

Features:

- With one or two drawer containers
- Container with one maxi or two medium-sized drawers with soft-close.
- In five standard decors (see page 17), optional in other decors
- Metal elements in white, titanium, black-brown, or chrome (additional charge)

Manicure Table Cube Select

- Height: 81 cm
- Width: 125 cm
- Depth: 50 cm



Manicure Table Cube Select Duo

- Height: 81 cm
- Width: 154 cm
- Depth: 50 cm



Storage space upon request

When equipping the container(s), you can choose between one large-capacity drawer with two spacious inner compartments or two medium-sized drawers.



Metal parts in chrome

In addition to the standard colors white, black-brown, and titanium, the bases of the Cube manicure table are also available in elegant chrome.



Perfectly combinable

For practical working and a uniform appearance, the Cube Select manicure table can be combined with the Cube Select Trolley (see page 264).

Hotel Das Dorner

South Tyrol, Italy

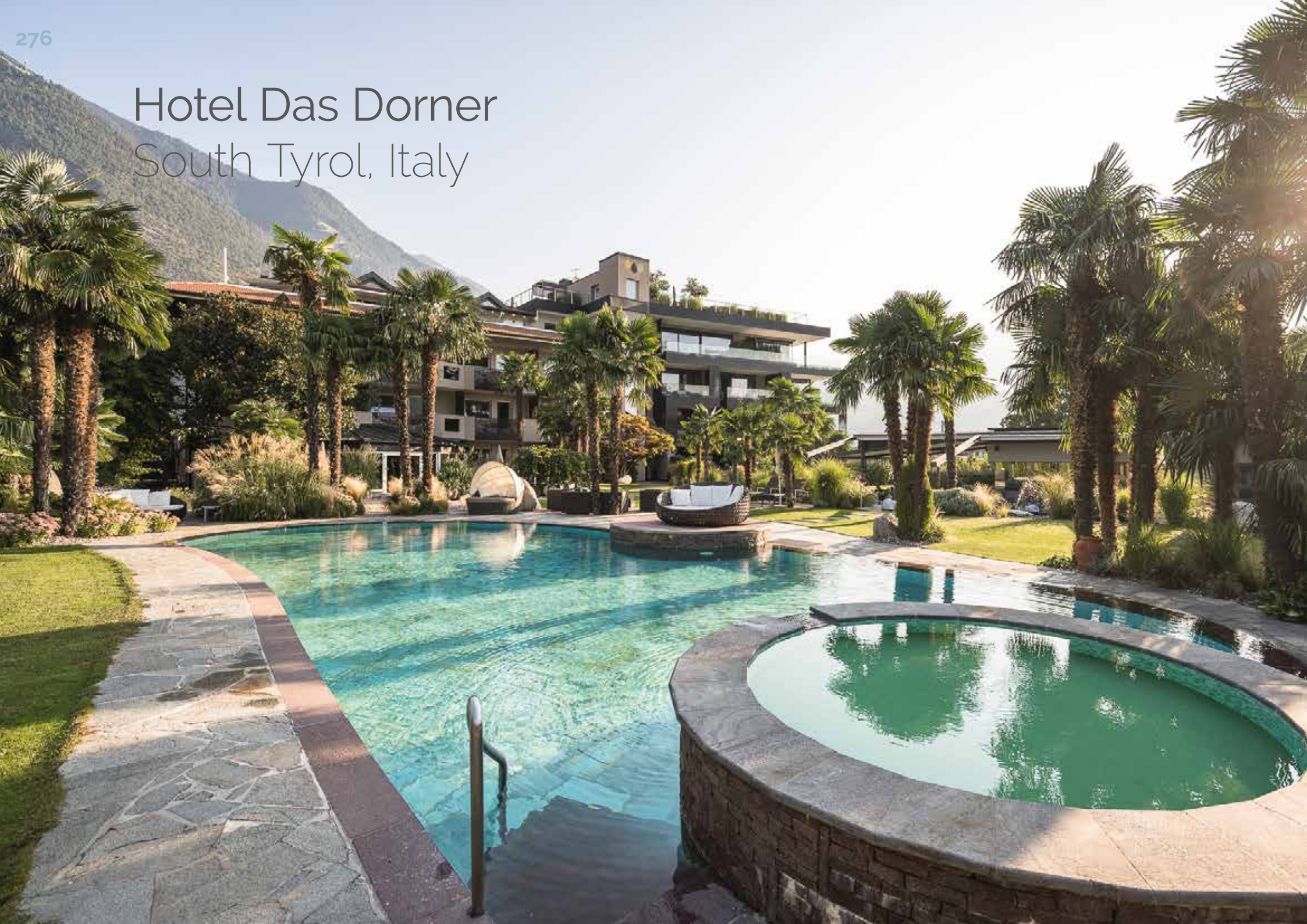



Stools & Chairs

Stools & Chairs

Not only your customers should be comfortable during the treatment! In order to be able to work comfortably and efficiently, the working chair factor plays a role that is not to be underestimated. Here, the focus is on ergonomics. This includes not only a comfortable seat surface, but also optimum adjustability. Our stools and chairs offer you all these features. Find exactly the right chair to suit you and your work from our wide range of products.

We also don't come up short in terms of looks. Optionally, you can configure our working chairs, in addition to the standard white, in different colors to suit your personal ambience. In addition, with our four castor base versions, we offer optimum possibilities to configure your personal working chair. Optional extras like our Floating feature and Airback-Technology round out our offering.

Features:

- Stools and chairs come standard with white upholstery and black base
- Synthetic leather cover optional in various colors from the current Gharieni or Ferrari Stamskin color collection (see catalog cover)
- Rotatable seat
- Rubber castors with Roll-Stop function
- Comfortable upholstery
- Washable and durable cover
- Pneumatic height adjustment
- 5-castor safety base
- Six different castor base versions



Foot release (height adjustment by foot) 42518

,-,-

Footrest ring (Footrest for high stools/chairs) 42500

,-,-



Six stool bases to choose from

For most of our stools we offer six bases to choose from. By default, a black star with black pneumatic spring is included in the price.

Stool-base, standard, black, ø 60 cm	included.
Stool-base, titanium, ø 62 cm	,-,-
Stool-base, chrome, ø 62 cm	,-,-
Hocker-Fuß, small, black, ø 50 cm	,-,-
Hocker-Fuß, small, black/chrome, ø 50 cm	,-,-
Stool-Star, small, chrome, ø 50 cm	,-,-

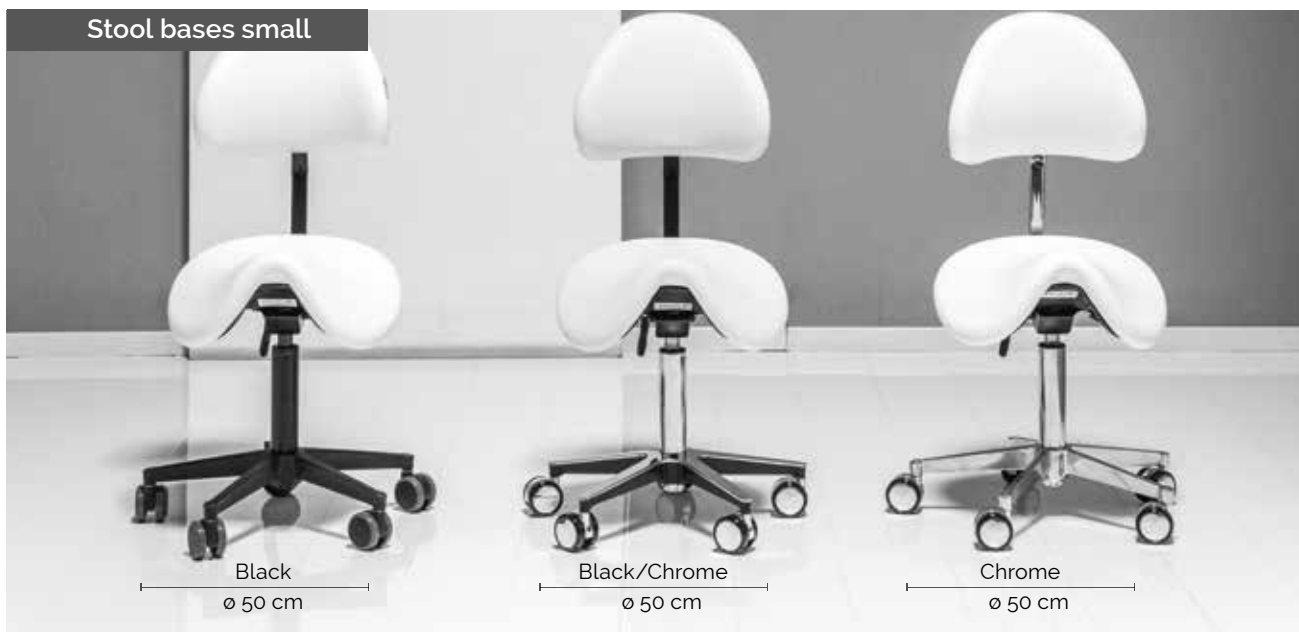

Upholstery in different colors

Our stools and chairs come standard equipped with white synthetic leather. Optionally, you can also choose a colorful cover from our current Gharieni or Ferrari Stamskin color chart (page 21).

Additional color charge stool, standard upholstery	,-,-
Additional color charge stool, Ferrari Stamskin upholstery	,-,-
Additional color charge chair, standard upholstery	,-,-
Additional color charge chair, Ferrari Stamskin upholstery	,-,-

Stools & Chairs



Anatomical saddle-seat stool
Large

59-80 cm height adjustment

Art. 42512



Manual
air chamber
pump

Integrated
air chambers



Anatomical saddle-seat stool
Large "Air"

59-80 cm height adjustment
integrated air chambers for pressure relief

Art. 42412



Adapted to the
male anatomy



Anatomical saddle-seat stool
Large "For Men"

59-80 cm height adjustment
Cut-out in the front seat area

Art. 42411



Chair/Stool "Anatomical saddle-seat"

Our specialists when it comes to ergonomics are the anatomical saddle-seat stools and chairs. Thanks to their specially curved seat design in the Large and Small versions, the saddle-shaped seats ensure optimal pressure distribution in the buttock-area while relieving the strain on the thighs. The "For Men" model, with its recess in the front part of the seat, also caters to the special ergonomic needs of men.

The "floating" version also offers a seat that swings in all directions to maintain the mobility of the pelvis and promote the flexibility of the discs.

All models have the obligatory height adjustment and the five-caster safety base. The chair model is also equipped with an adjustable backrest and a tilting seat.

Features:

- Anatomically-shaped rotating saddle-seat
- Pneumatic height adjustment
- Comfortable upholstery
- Chair version with inclinable seat to relieve pressure on the thighs
- "Air" chair version with air chambers to relieve pressure
- Washable and durable cover
- Synthetic leather cover in white
- 5-caster safety base
- Rubber castors with Roll-Stop function
- Optional with floating equipment: swinging, adaptable to the movement of the seat, in two types of firmness (soft and medium)
- Base in three colors: Black (standard), titanium, or chrome
- Four base versions (see page 283)



Anatomical saddle-seat stool Small "Floating"

47-63 cm height adjustment
with floating seat:

Art. 42401W	floating	,-
Art. 42401OF	without floating	,-



Anatomical "Small" saddle-seat chair

Height adjustment 47-63 cm (short pneumatic
spring), 56-80 cm (long pneumatic spring)

Art. 42501	with short pneumatic spring	,-
Art. 42498	with long pneumatic spring	,-

Stools & Chairs

Chair/Stool "Saddle-seat"

Our saddle-seat chairs or stools have a specially shaped seat similar to a bicycle. The advantage here: The recesses on the seat minimize the unpleasant pressure of the seat on the thighs. The durable synthetic leather upholstery is available in different colors (see color chart in the cover)

All models have the obligatory height adjustment and the five-castor safety base. The chair model is also equipped with an adjustable backrest as well as a tilting seat.

Features:

- 50-62 cm height adjustment
- Saddle-shaped, rotating, flat seat
- Pneumatic height adjustment
- Chair version optionally with inclinable seat to relieve pressure on the thighs
- Comfortable upholstery
- Washable and durable cover
- Synthetic leather cover in white, additional colors optional
- 5-castor safety base
- Rubber castors with Roll-Stop function
- Base in three colors: Black (standard), titanium, or chrome
- Four base versions (see page 283)



Saddle-seat stool

Art. 42502

7,-



Saddle-seat chair

Art. 42506

7,-

Art. 42509 with inclinable seat

7,-

"Round" chair/stool

Our round stools and chairs feature comfortable and robust upholstery.

The durable synthetic leather cover is available in different colors (see color chart in the cover)

All models have the obligatory height adjustment and the five-castor safety base. The chair model is also equipped with an adjustable backrest as well as a tilting seat.

Features:

- 50-62 cm height adjustment
- Round, rotating, flat seat
- Pneumatic height adjustment
- Chair version optionally with inclinable seat to relieve pressure on the thighs
- Comfortable upholstery
- Washable and durable cover
- Synthetic leather cover in white, additional colors optional
- 5-castor safety base
- Rubber castors with Roll-Stop function
- Base in three colors: Black (standard), titanium, or chrome
- Four base versions (see page 283)



Stool with round seat

Art. 42503

,-,-



Chair with round seat

Art. 42505

Art. 42508 with inclinable seat

,-,-

,-,-

Stools & Chairs



Air-Floating System:
Integrated air chambers
for more seating comfort

"Oval" chair

Art. 42515	,-,-
Art. 42516 with inclinable seat	,-,-
Art. 42515AF with Air-Floating-System	,-,-
Art. 42516AF inclinable AFS	,-,-



"Dental type" chair

Art. 72100	,-,-
Art. 72101 with Floating-Option	,-,-

"Oval" chair

With its wider seat and curved, height-adjustable backrest, the chair with oval seat provides comfort. In addition, it can be equipped with the Air-Floating system, which with its air chambers allows the adjustment of the seat upholstery to your personal needs. The optional seat tilt adjustment provides relief for the thighs.

Features:

- Pneumatic height adjustment of 50-63 cm
- Rotating oval seat
- Optionally with inclinable seat to relieve pressure on the thighs
- Washable and durable cover
- Synthetic leather cover in white or color
- Optionally with Air-Floating System (AFS) for more comfort and to avoid pressure points
- 5-caster safety base
- Rubber castors with Roll-Stop function
- Base in three colors: Black (standard), titanium, or chrome)
- Four base versions (see page page 283)

"Dental type" chair

With this functional chair, the backrest can also be moved to the left and right while seated and can therefore also be used as an armrest.

The chair is height-adjustable via a lever and has a 5-caster safety base.

Features:

- Pneumatic height adjustment of 50-62 cm
- Round seat and rotating backrest
- Comfortable upholstery and upholstered backrest
- Optional with floating equipment: swinging, adaptable to the movement of the seat, in two types of firmness
- Durable cover in white or color
- 5-caster safety base
- Rubber castors with Roll-Stop function
- Standard with black base, optional in titanium or chrome
- Four base versions (see page 283)

"Small" chair

With its angular shape, the "Small" is one of the classic working chairs. It features enormous versatility: Whether with or without armrests, with or without castors, or as a makeup chair, the "Small" offers the right seating to meet every need.

The standard white seat and backrest can also be chosen in one color from our color chart (see cover).

In addition to the obligatory height adjustment, the makeup chair has a foot rest ring for optimum seating comfort.

Features:

- "Small" without armrests height adjustment: 47-60 cm, "Small" with armrests: 40-53 cm, "Small" makeup chair: 57-83 cm
- Rotating, angular chair
- Optional: inclinable seat to relieve pressure on the thighs
- Comfortable upholstery and backrest
- Washable and durable cover
- Synthetic leather cover in white or color
- Choose from castors or fixed base
- Rubber castors with Roll-Stop function
- Comes standard with a black base, optional in titanium or chrome (depends upon the model)
- Four base versions (see page 283)



"Small" chair without armrest

Art. 42504 -,-
Art. 42507 with inclinable seat -,-

"Small" chair with armrest

Art. 42555 -,-

"Small" makeup chair

Art. 42076 -,-

Stools & Chairs

"Square" chair

A modern design with clean lines and extremely comfortable – this is the "Square" Chair. Whether as a working chair with and without a backrest or as a makeup chair, the Square offers an exclusive solution for most requirements. The robust, easy-to-clean synthetic leather upholstery is available as standard in white or optionally in other colors from our current color charts (see cover). In addition to the obligatory height adjustment, the makeup chair has a footrest ring for optimum seating comfort.

Features:

- In three chair versions: Working chair with and without armrests or makeup chair
- Pneumatic height adjustment from 47-63 cm (working chair), approx. 57-83 cm (makeup chair)
- Rotating, angular chair
- Comfortable upholstery and backrest
- Armrests
- Washable and durable cover
- Synthetic leather cover in white or color
- Optionally with castors or fixed base
- Rubber castors with Roll-Stop function



"Square" chair without armrest
Art. 42802 ,--



"Square" chair with armrest
Art. 42800 ,--



"Square" makeup chair
Art. 42801 ,--

TOPSI

Vienna, Austria





Moers, Germany | Sales + Showroom // Gharieni Group GmbH • Gutenbergstr. 40 • D-47443 Moers

Moers, Germany | Distribution + Service // Gharieni Group GmbH • Am Schürmannshütt 24 • D-47441 Moers

Tel: +49 - (0) 28 41 - 88 300 - 0 • Fax: +49 - (0) 28 41 - 88 300 - 333 • www.gharieni.de • info@gharieni.com

Ettlingen | Germany // Gharieni Süd GmbH • Siemensstr. 11 • D-76275 Ettlingen

Tel: +49-(0)72 43-33 22-363 • Fax: +49-(0)72 43-33 22-391 • ettlingen@gharieni.com

Nederweert | BeNeLux // Gharieni Nederland BV • Hulsenvweg 14 • NL-6031 SP Nederweert

Tel: +31 (0) 495 - 63 30 36 • Fax: +31 (0) 495 - 62 66 63 • www.gharieni.nl • info@gharieni.nl

Dubai | UAE // Gharieni Middle East FZ-LLC • Park Hyatt Hotel • Dubai Creek Club St., P.O. Box 333203 • Dubai

Tel: +971 (0) 4 602 1819 • www.gharieni.ae • info@gharieni.ae

Aventura | USA // Gharieni USA Inc. • JW Marriott Miami Turnberry Resort & Spa • 19999 West Country Club Drive

Aventura Florida 33180 • Tel: +1 (855) 378 4772 • www.gharieni.com • info@gharieni.com